

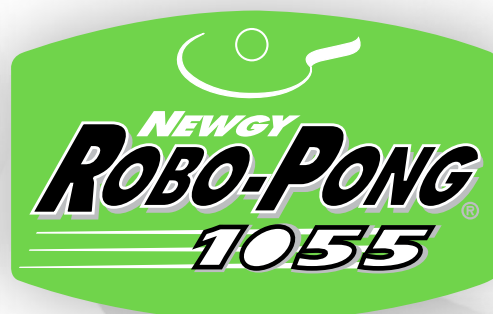

- 2055 Quick Start 2
- 1055 Quick Start 4
- Operation 6
- Robot Positions 18
- Misc. Adjustments..... 19
- Drill Diagrams21
- Speed Calib. Target ..27
- RP.2.PC 28
- Important Notices.... 34
- Take-Down, 205535
- Maintenance37
- Chip Replacement ... 38
- Exploded Views 39
- Parts List..... 44
- Warranty & Repair ... 46



Robo-Pong 2055 and Robo-Pong 1055
OWNER'S MANUAL

2055 QUICK START

1 Verify All Parts

Unpack all the parts and check that all are present. If unable to identify a part, look for a small silver label with the part name. If a part is missing, please contact Newgy. You may want to keep your box and styrofoam pieces in case you need to ship your robot.

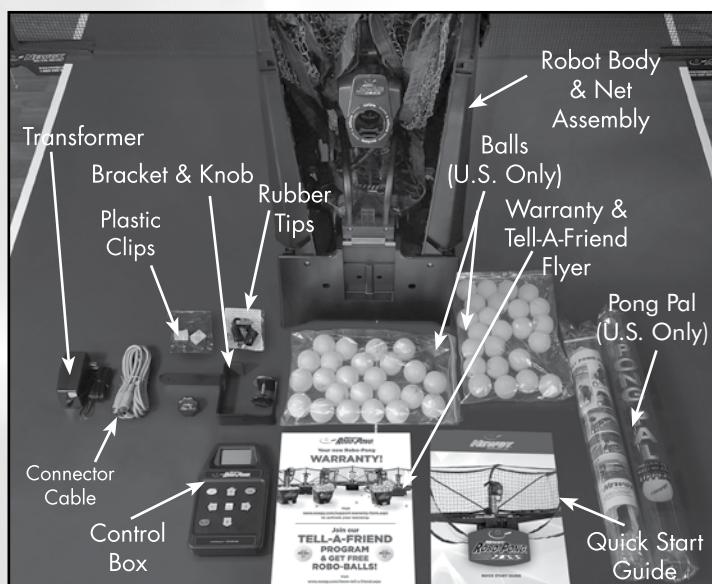

3 Spread Support Legs Apart

Spread out the support legs to their fully open position.

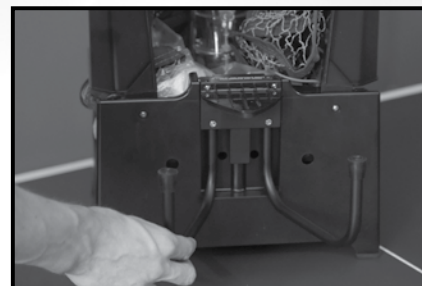

4 Join Net Support Tubes

Turn the robot around 180° so the Net Support Tubes are now facing you. Grasp the second tube from your right and pull up, removing it from its storage hole. Place the bottom of this tube into the top of the first tube on your right as shown. Repeat on the left side.



2 Pull down support legs

Place the robot on the table with the open front side facing you. Pull the curved black metal support legs toward you.

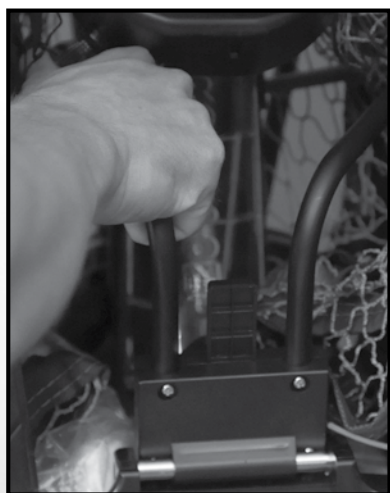

5 Gently Lower Ball Trays

Grasp one of the Ball Return Trays, lift straight up to unlock it, grasp the adjacent Net Support Tube, and slowly lower them into position. Be careful not to let the tray or support tube slam down. Repeat on the other side.



6

Attach the Robot to the Table

Pick up the robot by the center base and secure it to the table by angling it downward and against the table. The support legs should be as wide as possible before they go underneath the table and the front support triangle sits on top of the table.



7

Place Balls* in Bucket

Open the bag(s) of balls. Wash and dry them, and then place in the Ball Tray. Add any additional new table tennis balls that have been washed and dried, or any used balls with a worn surface. All balls must be 40mm or 40+mm in diameter. (*Included with U.S. robots only.) Do not mix 40mm and 40+mm balls.

8

Adjust Head Angle

Tilt the head downward as far as possible by loosening the Brass Knob and then re-tighten after moving head. Verify that the word "topspin" is at the top of the ball discharge hole.



9

Attach the Side Nets

Attach the side nets to your table tennis table net by slipping the red flexible band over your table net's support base and looping it over the table net's clamp screw.



10

Connect Cable to Robot

Plug one end of the Connector Cable into the 5-Pin Connector on the back of the robot as shown. Take the other end of the cable to the player's end of the table.

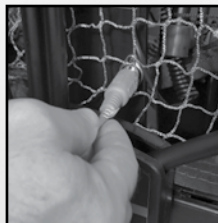

11

Attach Bracket to Control Box

Turn Control Box upside down on the table. Take the Mounting Bracket and align the hole in the mounting arm with the threaded insert of the Control Box. Secure bracket with Mounting Screw. Leave Control Box laying face down.



12

Connect Cables to Control Box

Bring the free end of the Connector Cable to the player's end of the table. Plug the Connector Cable into the 5-pin socket on the bottom of the Control Box. Then insert the Transformer's pin into the power jack of the Control Box.



13

Adjust Bracket to Top Thickness

Pick up the Control Box and looking across the round rubber pad of the Adjustment Screw, raise or lower the height of the rubber pad so it aligns with the nearest mark on the bracket's label that corresponds with the thickness of your table's top.



14

Attach Control Box To Table

Angle the opening between the two rubber pads of the Mounting Bracket towards the bottom of your table's apron. Slip the bracket onto the table. The rectangular rubber pad of the bracket should sit flat on the table's top surface. If it is not flat, loosen or tighten the Adjustment Screw until the pad lays flat. This is not a clamping mechanism—do not overtighten!



15

Position Your Control Box

Place the Control Box on the side of the table about one foot from the end. If you're right-handed, place it on the left side of the table. If you're left-handed, place it on the right side.

Plug the Transformer into any suitable electrical socket.

NOTE: Do Not power down your robot by pulling the power plug from the control box or the wall outlet. Doing so may cause your robot to not function properly and may void your warranty.



17

Get Ready To Play!

If not already on, turn the Control Box on by pressing the Power button. Adjust the Ball Speed to 8 by pressing the + button. Pick up your paddle and press the Stop/Start button. The balls will start loading into the robot. It takes about 15 seconds before the first ball is shot out. It will be delivered down the centerline of the table with Topspin.

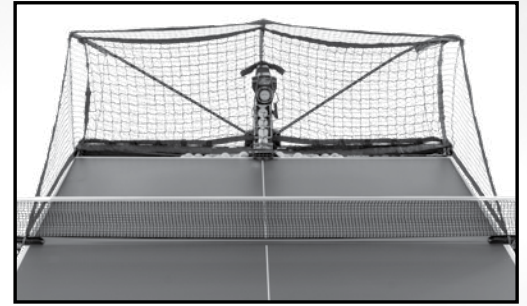

16

To Connect Control Box to PC (Optional)

If you want to connect your robot to a PC, connect any USB-A to USB-B Printer cable (not included) to both the control box and your Windows® PC.

1055 QUICK START

1

Verify All Parts

Unpack all the parts and check that all are present. If unable to identify a part, look for a small silver label with the part name. If a part is missing, please contact Newgy. You may want to keep your box and styrofoam pieces in case you need to ship your robot.

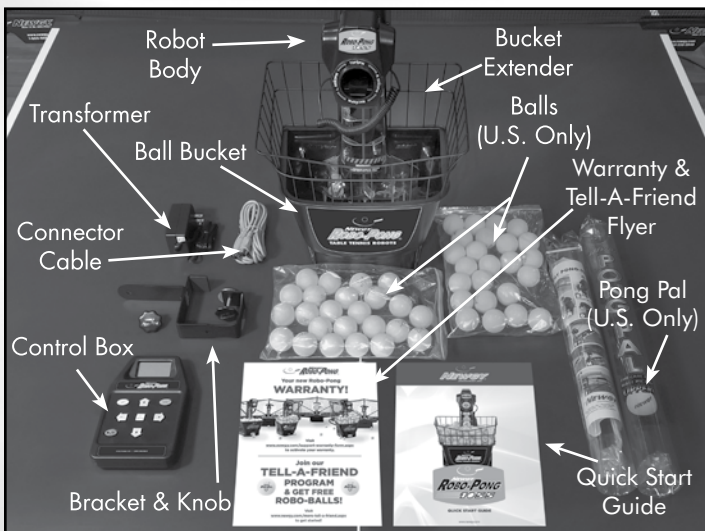

2

Detach Robot Body

Loosen the two Wing Nuts holding your robot body onto the Ball Bucket. Rotate the black, rectangular Clip Washers 180°. Pull the Robot Body off the bucket.



3

Attach Bucket Extender

Slide the Bucket Extender onto the top of the bucket so that the hooks on the bottom of the Extender capture the top lip of the Bucket. Stop when the hook on the front of the Extender grabs the front lip of the Bucket. It may be necessary to lift the bottom rear of the Extender over the Locating Tab protruding above the rear lip of the Bucket. Reattach the Robot Body to the Bucket by reversing step 2.



4

Place Balls* In Bucket

Open the bag(s) of balls. Wash and dry them, and then place in the Ball Bucket. Add any additional new table tennis balls that have been washed and dried, or any used balls with a worn surface. All balls must be 40mm or 40+mm in diameter. (*Included with U.S. robots only.) Do not mix 40mm and 40+mm balls.

5

Adjust Head Angle

Tilt the head downward as far as possible by loosening the Brass Knob and then re-tighten after moving head. Verify that the word "topspin" is at the top of the ball discharge hole.

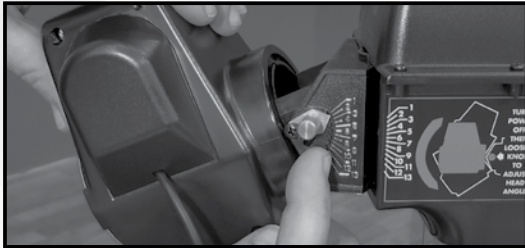

6

Position Robot On Table

Position the robot in the center of the table close to the endline as shown. The robot's head should be in line with the centerline of the table.



7

Connect Cable To Robot

Plug one end of the Connector Cable into the 5-Pin Connector on the back of the robot as shown. Take the other end of the cable to the player's end of the table.



8

Attach Bracket To Control Box

Turn Control Box upside down on the table. Take the Mounting Bracket and align the hole in the mounting arm with the threaded insert of the Control Box. Secure bracket with Mounting Screw. Leave Control Box laying face down.



9

Connect Cables To Control Box

Bring the free end of the Connector Cable to the player's end of the table. Plug the Connector Cable into the 5-pin socket on the bottom of the Control Box. Then insert the Transformer's pin into the power jack of the Control Box.



10

Adjust Bracket to Top Thickness

Pick up the Control Box and looking across the round rubber pad of the Adjustment Screw, raise or lower the height of the rubber pad so it aligns with the nearest mark on the bracket's label that corresponds with the thickness of your table's top.

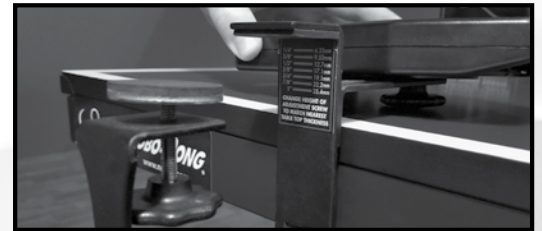

11

Attach Control Box To Table

Angle the opening between the two rubber pads of the Mounting Bracket towards the bottom of your table's apron. Slip the bracket onto the table. The rectangular rubber pad of the bracket should sit flat on the table's top surface. If it is not flat, loosen or tighten the Adjustment Screw until the pad lays flat. This is not a clamping mechanism—do not overtighten!



12

Position Your Control Box

Place the Control Box on the side of the table about one foot from the end. If you're right-handed, place it on the left side of the table. If you're left-handed, place it on the right side. Plug the Transformer into any suitable electrical socket. **NOTE: Do Not power down your robot by pulling the power plug from the control box or the wall outlet. Doing so may cause your robot to not function properly and may void your warranty.**



13

To Connect Control Box to PC (Optional)

If you want to connect your robot to a PC, connect any USB-A to USB-B Printer cable (not included) to both the control box and your Windows® PC.



14

Get Ready To Play!

If not already on, turn the Control Box on by pressing the Power button. Adjust the Ball Speed to 8 by pressing the + button. Pick up your paddle and press the Stop/Start button. The balls will start loading into the robot. It takes about 15 seconds before the first ball is shot out. It will be delivered down the centerline of the table with Topspin.



OPERATION OF YOUR ROBOT

CONTROL BOX FEATURES (ALL MODELS)

NOTE: Do Not power down your robot by pulling the power plug from the control box or the wall outlet. Doing so may cause your robot to not function properly and may void your warranty. Always power off through the control box menu/button.

All robot functions are controlled electronically by the Control Box. It uses a powerful programmable microprocessor to run motors, monitor sensors, execute programs, and display information on an easy to read LCD. You control it with 8 color coded buttons to navigate through the menus and adjust values of each function. Figures 1A and 1B point out the button, connections, and features of the digital Control Box.

1. **LCD**—Displays the menus, messages, and settings for your robot in one of 6 different languages.

2. **Power (I/O) Button**—Colored orange, this button turns your Control Box on or off.

3. **Test (✓) Button**—Colored yellow, this button has various functions depending upon the currently selected mode. These functions are detailed under the MODE sections starting on page 7.

4. **Stop/Start (■/▶) Button**—Colored red and green, this button starts and stops ball delivery. After pressing

this button, there will be a 3 second start up beeping sequence to allow time to ready yourself for the first shot.

5 & 6. **Minus (-) & Plus (+) Buttons**—Colored gray and shaped like arrows pointing left and right, press to increase or decrease values or otherwise allow selection of the parameters available for the selected function.

7 & 8. **Up (↑) & Down (↓) Buttons**—Colored gray and shaped like arrows pointing up and down, press these buttons to navigate up and down through the menus.

9. **OK/MENU Button**—Colored white and square-shaped, press this button to go to the Main Menu and select the Mode.

10. **Power Jack**—Plug the transformer in here to connect the robot to an electrical source.

11. **5-Pin Connector**—Plug the gray Connector Cable in here to connect the Control Box to the main robot body.

12. **Female USB Connector**—Plug the USB cable (user supplied) in here to connect the robot to a PC.

13. **Male DB-9 Connector**—Plug the Linking Cable from the Pong-Master Scoreboard in here. Pong-Master is an optional accessory.

14. **Mounting Screw Insert**—Screw the black-knobbed Mounting Screw in here to secure the Control Box to the Control Box Mounting Bracket.

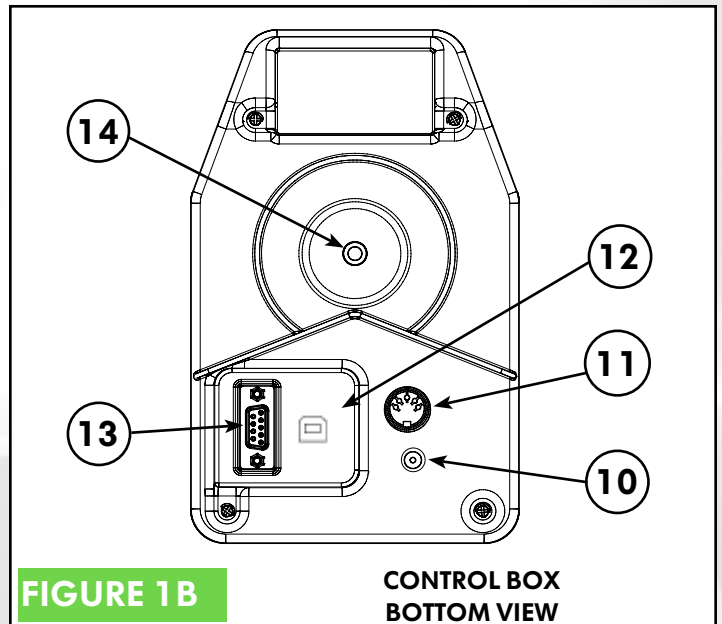
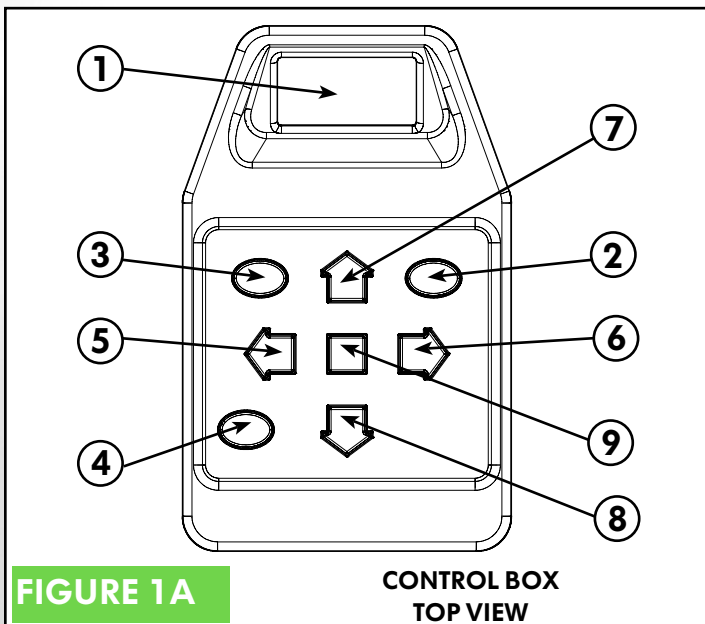

CONTROL BOX MENU SYSTEM (ALL MODELS)

All functions of the Control Box are accessible through its menu system. The menu system is displayed on its LCD screen. Since the screen is limited to showing a maximum of 4 lines of 16 characters, most menus will have more than 1 page. Additional pages of a menu are indicated by a downward arrow on the bottom line of the display or an upward arrow on the top line. This menu system functions very much like the menu system on many cell phones.

To navigate the menu system, simply press the Down Button to select the next line. As lines are selected they reverse colors with a black background and white characters. When deselected, a line will have black characters on a white background. If you navigate to a bottom line that contains a downward arrow (as shown at the end of the WAIT line of the L POSITION illustration to the right), pressing the Down Button will reveal the next page with up to 4 new functions.

You may also go upward through a menu by pressing the Up Button. And if you arrive at a top line with an upward arrow (as shown in the COUNT illustration on the next page), pressing the Up Button will reveal a new page of functions.

Once you have selected a function, you change the values for that function by using the - and + Buttons. If the values are numerical, the - Button will decrease the value while the + Button increases the value. A single quick button press will change the value by one increment. Holding the button down will accelerate the rate at which the values change until you release the button.

MAIN MENU (ALL MODELS)

The Main Menu serves as the access control to the 4 operating modes. It can be accessed by pressing the OK/Menu Button. When that button is pressed, the Main Menu is displayed. The Main Menu consists of a single page. This menu has 4 selections: (1) NORMAL, (2) DRILL, (3) PC, and (4) SETUP. To enter one of these modes, select one and then press the OK/Menu Button.

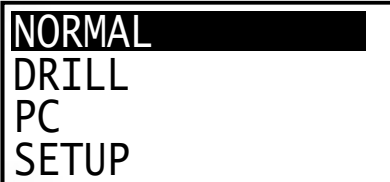

Tip: Press OK/Menu once in any mode to instantly return to the Main Menu. The robot will cease any action it's currently performing and wait for your next instruction. This is especially helpful if you get "lost" in the menu system.

NORMAL MODE (ALL MODELS)

NORMAL Mode is used when the player wants to set each function manually. This is most like how other robots typically function. Normal Mode is also the default mode when the Control Box is first plugged into power. This mode has 3 pages of functions.

Tip: If ever you want to return to Normal Mode, press the OK/Menu Button twice from any menu to go to Normal Mode.

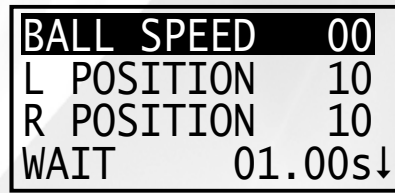

BALL SPEED sets how fast the Ball Speed Motor spins. This determines both how fast the ball is discharged and how much spin is placed on the ball. The higher this setting the more speed and spin. Setting of 0 means the motor is off and will result in balls falling out of the discharge hole. Maximum setting is 30. (**Tip:** for top ball speed, clean the Discharge Wheel and Friction Block before using. See page 37.)

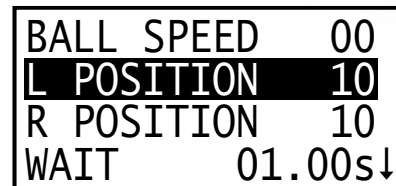

L POSITION sets the leftmost position to which a ball is delivered. A setting of 0 correlates with an extreme angle off the left sideline; 5-6 with the middle of the left court; 10 with the centerline of the table; 14-15 with the middle of the right court; and 20 with an extreme angle off the right sideline. Figure 2 below illustrates all of the 21 possible positions (0-20).

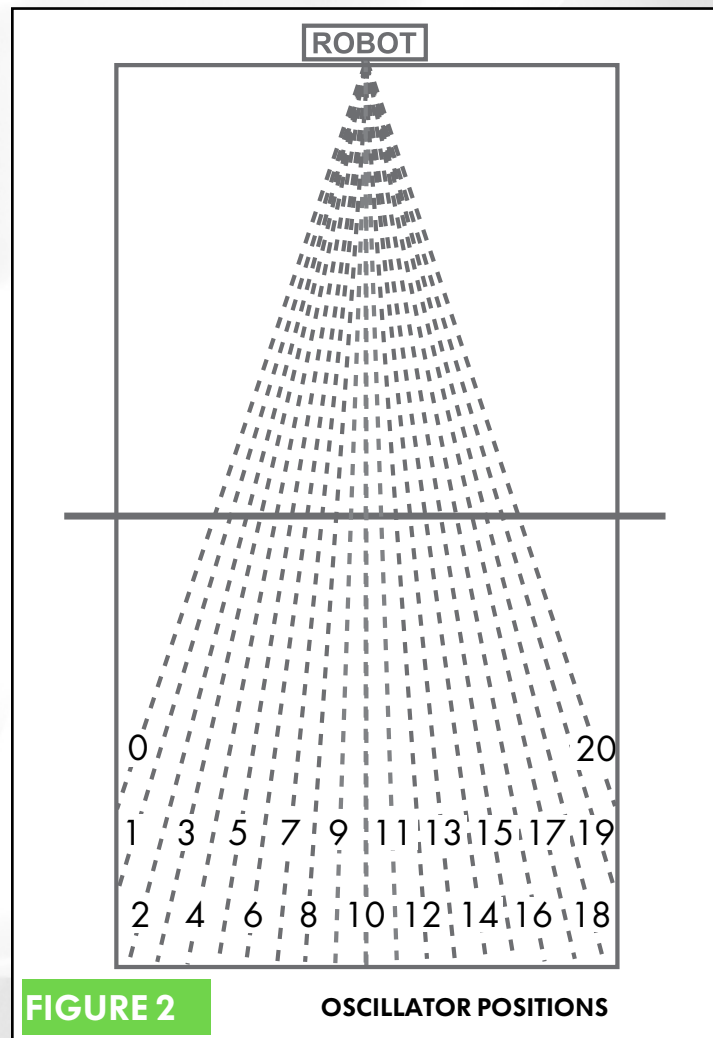

A position setting is really a line of direction coming from the robot. Selecting a position number results in a ball being thrown somewhere along the dotted line that corresponds with the number. The Head Angle, Ball Speed, and Spin determine where a ball is delivered along that line.

If the robot is not positioned at the center of the endline, these trajectories will change accordingly. See POSITIONING YOUR ROBOT & CONTROLS on page 18 for more info.

When L POSITION is set, it automatically sets R POSITION. If both positions are the same, the ball will be thrown to only one position. If L POSITION and R POSITION are different, then balls are alternately thrown first to one position and then to the other position.

BALL SPEED	00
L POSITION	10
R POSITION	10
WAIT	01.00s↓

R POSITION sets the rightmost position to which a ball is delivered. This setting can be changed without affecting the L POSITION. However, if L POSITION is changed, R POSITION will need to be reset. Remember, when L & R settings are the same, balls are delivered to only one position. When they are different, balls are delivered alternately between the two positions.

BALL SPEED	00
L POSITION	10
R POSITION	10
WAIT	01.00s↓

WAIT is the amount of time (interval) between one shot and the next shot in seconds. An easy way to remember this setting is to think, "How long do I want to wait before the next shot?" If the pace seems too slow and you want to wait less, decrease WAIT and ball delivery becomes more rapid. If the pace is too fast and you want to wait more, increase WAIT and ball delivery will slow down.

WAIT can be changed in 0.05 second increments from 0.35 to 50 seconds. However, the minimum setting is dynamically linked to L POSITION and R POSITION settings. The larger the difference between L and R, the longer the robot must wait before delivering the next ball. This is because it takes a minimum amount of time for the robot to change positions. For every difference of 2 in the settings between L & R, another 0.05 is added to WAIT.

For example, if L & R are both set to 5 (no oscillation), the minimum WAIT is 0.35 seconds. But if L is set to 0 and R to 20 (a difference of 20), 0.50 is added to the minimum WAIT to allow time for the robot's head to sweep from the far left sideline to the far right sideline. In this example, the minimum WAIT would change from 0.35 to 0.85 seconds with a difference of 20 in L & R positions. This ensures that a ball is not shot out until the robot has swept to the correct position.

Please be aware that WAIT is not absolute. This setting may vary a little due to a number of factors, but in general, it is accurate to within $\pm 10\%$. WAIT also is involved in the calculations for TIME (explained after COUNT).

COUNT	0000↑
TIME	0:00:00
OSC RANDOM	OFF
SPEED RANDOM	00↓

COUNT indicates the number of balls that the robot delivers before it stops automatically. If COUNT is set to 0, COUNT is ignored and the robot will keep throwing balls until the Stop/Start Button is pressed.

If COUNT is more than 0, it will decrement by 1 every time a ball is thrown until it reaches 0. If Stop/Start Button is pressed before COUNT reaches 0, delivery will stop. Pressing the Stop/Start button a second time will resume the COUNT where it was when it was stopped. Once COUNT reaches 0, it must be reset to a new number before it becomes active.

COUNT is synced with TIME (discussed next). As COUNT is changed, TIME dynamically changes to reflect a multiplication of COUNT times WAIT. For example, with WAIT set to 1 second and COUNT to 61, TIME would show 0:01:01 (1 minute, 1 second).

COUNT	0000↑
TIME	0:00:00
OSC RANDOM	OFF
SPEED RANDOM	00↓

TIME shows how long the robot will continue throwing balls until it stops automatically. TIME is displayed in HR:MIN:SEC format. A display of 1:01:01 indicates 1 hour, 1 minute, and 1 second.

TIME is restricted to increments of WAIT rounded to the next second. For example, if WAIT is 1.50 seconds and TIME is set to 0:00:03, COUNT would show 2. If TIME is set to 0:01:30, COUNT would show 60. However, TIME cannot be set to something like 0:00:05 because that time is not an even increment of WAIT.

TIME is similar to COUNT—a setting of 0 deactivates this function and more than 0 causes the robot to keep running until the value becomes 0. Interrupting TIME by pressing the Stop/Start Button simply pauses the countdown until the Stop/Start Button is pressed a second time.

Having TIME and COUNT dynamically linked together makes it easy to regulate your training routine by number of balls thrown or by overall time. If you're used to doing a particular routine for 100 balls, set COUNT to 100 and the robot automatically calculates the time it takes to throw 100 balls. If you prefer to regulate your workouts by time, set TIME to 0:03:00, for example, to do your routine for 3 minutes before the robot stops automatically. If you don't want to use TIME or COUNT to stop ball delivery, set them to 0 and you can control ball delivery manually by pressing the Stop/Start button.

TIP: Since TIME and COUNT can be set to very high numbers, there is a trick to greatly speed up the rate at which the value changes. Press and hold the - or + Button and then press the OK/Menu Button. Values will change much more rapidly.

```

COUNT      0000↑
TIME        0:00:00
OSC RANDOM  OFF
SPEED RANDOM 00↓

```

OSC RANDOM turns the oscillator randomization feature on and off. It requires L POSITION and R POSITION to be set to different numbers for it to have any effect. When off, balls are thrown alternately to the left and right positions. When on, balls are thrown randomly *between* the left and right positions.

For example, if L POSITION is 5, R POSITION is 10, and OSC RANDOM is OFF, balls are delivered alternately to positions 5 and 10. However, if OSC RANDOM is changed to ON, then balls will be placed anywhere between positions 5 and 10; i.e., positions 5, 6, 7, 8, 9, or 10. The robot will pick one of these numbers and throw a ball to the position it chooses.

```

COUNT      0000↑
TIME        0:00:00
OSC RANDOM  OFF
SPEED RANDOM 00↓

```

SPEED RANDOM varies the BALL SPEED so balls are thrown to different depths on the table. The value entered is added to the value for BALL SPEED to give a range of numbers from which the robot can randomly pick.

For example, BALL SPEED is set to 12 and SPEED RANDOM is set to 6. This gives a range of ball speeds from 12 (very short, close to the net) to 18 (very deep, close to the endline). The robot will randomly pick a number from within this range—12, 13, 14, 15, 16, 17, or 18—and throw a ball at that speed.

A value of 00 means no randomization. Maximum value is 10. Be cautious about using too high of a value as it could cause balls to be thrown off the end of the table.

Tip: Set the BALL SPEED to the slowest desired speed first, say 15. Then, without changing the head angle, experiment to see what BALL SPEED setting will throw a ball just past the end of the table, say 19. Subtract 1 from this larger number to find the maximum speed that still lands the ball on the table—in this case, 18. Subtract the slowest ball speed, 15, from this maximum speed, 18, to give the maximum SPEED RANDOM setting—3.

```

WAIT RANDOM 0.00↑

```

WAIT RANDOM causes the WAIT setting to vary by a certain amount of time. The entered value is added to the WAIT time to provide a range of time for the interval between two consecutive shots. Like WAIT, this setting can be changed in increments of 0.05 seconds. Maximum WAIT RANDOM is 1.00 seconds. A setting of 0.00 means no randomization is added to the wait time.

For example, WAIT is 1.00 seconds and WAIT RANDOM is 0.20. These settings would provide a range of wait times

between 1.00 and 1.20 seconds. The robot could pick any time among the following—1.00, 1.05, 1.10, 1.15, or 1.20 seconds.

Using WAIT RANDOM makes it difficult to develop a rhythm and predict when the next ball will be delivered. This encourages the user to maintain a good ready position between each shot and only move after the ball is shot out from the robot.

Also be aware that the greater the WAIT RANDOM is, the less and less accurate TIME and COUNT become. This is because the amount of time between each ball can no longer be accurately calculated since the interval between each shot is constantly changing.

You can use 1, 2, or all 3 randomization controls at once. Combining them together can make for very unpredictable ball deliveries. It is recommended that you use *controlled randomization*. Add randomness in small increments only after consistency is attained without randomization. As technique improves, gradually increase the amount of randomization to more closely simulate live play.

In Normal Mode, the yellow Test Button is used to give 1 or more balls to test your settings. Press Test once and 1 will appear on screen. After a brief delay, 1 ball will be thrown using the current BALL SPEED and last position settings. If you hold the Test Button down, the number shown on screen will keep advancing in increments of 1 until you release the button. Then, that number of balls will be thrown. Please be aware that test balls thrown will not reflect any random settings chosen (random position, speed, or wait).

DRILL MODE (ALL MODELS)

```

NORMAL
DRILL
PC
SETUP

```

DRILL Mode allows access to the 64 drills that come pre-programmed with your robot. Select Drill Mode by going to the Main Menu, selecting DRILL and pressing OK. There are 2 pages of functions in Drill Mode.

The 64 drills have been carefully selected to offer a variety of drills for all playing levels, and to demonstrate how drills can be created for training footwork, forehand-backhand transitions, serve return, and attack of high balls or backspin balls.

Each drill is diagrammed in the DRILL DIAGRAMS section starting on page 21. It is recommended that you keep these diagrams next to your table tennis table when using Drill Mode to quickly refer to the diagrams and select a drill for training a particular aspect of your game. These diagrams also provide information on what type of shots the player is expected to use during the drill and what spin and head angle settings to use. Create your own drill diagrams by downloading a blank drills diagram page from the Downloads page of www.newgy.com, printing it off and using hand notations on those printed diagrams.

TIP: You can often create "new" drills by simply changing the HAND setting. So, for instance, if you are right handed and have RIGHT selected, Drill 52 will give two backhands and one forehand. By changing RIGHT to LEFT, this same drill will give you 2 forehands and 1 backhand.

DRILL#	01
SPIN	TOP
HEAD ANGLE	02.0
WAIT ADJUS	000%↓

The first 3 lines of each drill are reserved for settings that are predefined for each drill. Except for selecting another drill, these values cannot be changed. Press the + Button to select a drill with a higher ID number and the - Button for a lower numbered drill.

Once a drill is selected, you need to verify that the Spin (see page 16) and Head Angle (see page 15) are correctly set before starting a drill. Failure to do so will normally cause the drill to not run correctly and landing spots will be different than the way the drill was designed.

Regarding Head Angle, the angle indication mechanism is not precise. Therefore, it is recommended that if balls within a drill are not landing in the correct spot, that you first try slightly nudging the head angle either up or down to see if this corrects the problem. For instance, if a drill starts with a short serve, and the serve often hits the net, raise or lower the head angle slightly so that the serve still lands short, but it clears the net without touching it.

DRILL#	01
SPIN	TOP
HEAD ANGLE	02.0
WAIT ADJUS	000%↓

WAIT ADJUS is used to increase or decrease the wait time between each shot. The value can be changed from -100% to +900% in 10% increments. Since WAIT is adjusted by percentage, even drills that have different WAITS programmed within the drill will still run correctly. Players of many different levels can use the same drill without needing to rewrite the drill.

For example, let's say a drill has a WAIT of 1 second between the 1st and 2nd ball and a WAIT of 0.80 seconds between the 2nd and 3rd ball. If WAIT ADJUS is set to +010%, the 1st WAIT would be changed to 1.1 seconds and the second WAIT to 0.88 seconds. The drill would run slower so the player has more time between each ball.

On the other hand, if WAIT ADJUS is set to -010%, the 1st WAIT is reduced to 0.90 seconds and the 2nd one to 0.72 seconds. This causes the drill to run at a faster pace, reducing the time the player has between every ball.

Except for the 5 Beginner level drills, the drills that come with your Robo-Pong are written to simulate *real-time rallies*. This means that wait times were selected to closely approximate the actual wait times in a rally between two players. If you are unable to keep up with the pace, add a positive WAIT ADJUS until you can maintain the pace for several minutes. Your goal should be to gradually and systematically decrease the WAIT ADJUS to 0.

And once you can keep pace with a drill in real time, then strive to practice the drill at faster than real time by decreasing WAIT ADJUS to a negative value. By using this principle of *progressive overloading*, you can train your movements to flow smoothly at faster and faster speeds.

You will react faster to the ball in actual game rallies and you may start dominating rallies simply because you are quicker than your opponent.

SPEED ADJUST	0↑
# OF REPS	0000
TIME	0:00:00

SPEED ADJUST increases or decreases the BALL SPEEDS that are preset in a drill. The values range from -9 to +9. The value is added to the BALL SPEED for each ball in a drill.

For instance, a drill has 2 balls in it, one with a BALL SPEED of 14 and the other, 16. If SPEED ADJUST is set to +2, the speed of the 1st ball changes to 16 and the 2nd ball to 18. If set to -2, 1st ball changes to 12 and the second to 14.

SPEED ADJUST should be used sparingly, especially on drills that have both short balls and long balls. Adjusting the speed upward on such a drill would likely make the short ball land too deep and the deep ball get thrown off the table. Adjusting the speed downward would likely make the short balls fall into the net and the deep balls land in the middle of the table.

SPEED ADJUST is best used for drills having a single BALL SPEED. These drills have all balls landing at the same depth on the table. Check Preview (see beginning of page 10) to see if all balls in a drill are thrown at the same depth. Decrease SPEED ADJUST to make balls land shorter on the table and increase it to get deeper balls.

SPEED ADJUST is also handy when used in conjunction with Head Angle. If the specified Head Angle results in a ball that has a higher trajectory than you prefer, simply lower the Head Angle and use a positive SPEED ADJUST to have the ball land at the desired depth on the table. Again, this works best on drills that have a consistent BALL SPEED set for the entire drill.

SPEED ADJUST	0↑
# OF REPS	0000
TIME	0:00:00

OF REPS is similar to COUNT of Normal Mode. It automatically stops ball delivery after the specified number of drill repetitions are completed. For instance, if set to 5, and there are 3 balls in the drill, the robot would run the drill 5 times (15 balls total) before stopping. Also a setting of 0 deactivates this function and drills can only be stopped by manually pressing the Stop/Start Button.

If a drill is paused (by pressing the Stop/Start Button), before # OF REPS equals 0, the drill will resume at the start of the repetition at which it was paused when the STOP/START button is pressed again. For example, # OF REPS is set to 5 and the drill is paused in the middle of the 3rd rep. When resumed, the drill would repeat the 3rd repetition since it did not completely finish when interrupted.

```

SPEED ADJUST 0↑
# OF REPS 0000
TIME 0:00:00

```

TIME stops a drill automatically after the specified amount of time has elapsed. Like Normal Mode, where **TIME** is dynamically linked to **COUNT**, in Drill Mode, **TIME** is dynamically linked to **# OF REPS**. You can increase or decrease **TIME** in increments of the estimated time it takes to complete 1 full repetition of a drill.

For example, if it takes approximately 5 seconds to complete 1 repetition of a drill, **TIME** would go up and down in increments of 5 seconds. If a drill contains variable **WAIT** times, this approximation will become less precise.

Also see **TIME** (for Normal Mode) on page 8 for further explanation of this function.

PC MODE (ALL MODELS)

```

NORMAL
DRILL
PC
SETUP

```

PC Mode is used whenever you want to connect your Robo-Pong to your Windows® PC to read drills from or write them to the Control Box and to run drills directly from the PC. This Mode consists of a single page:

```

PC MODE
MAKE CONNECTION
TO PC
RUN RP2.PC

```

After seeing this screen, please verify that your PC is connected properly via the USB port on the bottom on the Control Box. This connection routine is discussed in more detail on page 28. After making the connection, start up your PC and then launch the **RP2.PC** program that can be downloaded from Newgy.com.

After **RP2.PC** is launched, it takes several seconds to establish communications with the Control Box (be patient). Once the launch routine completes, it confirms the connection by displaying a message at the top of the program's main window.

Once the connection is confirmed, **RP2.PC** can be used to read from and write to the Control Box, and run drills direct from your PC. If you switch out of PC Mode after connecting, the check mark will disappear and you'll need to reestablish communication once you return to PC Mode by using the **AutoConnect** command. Please read the **RP2.PC** section (page 28) for more info.

Please be aware that a connection between your PC and the Control Box does *not* need to be established if you only want to open, work on, or save drills *stored on your computer's hard drive* (or external drive connected to your computer). A connection is only necessary whenever you desire to communicate with the Control Box via **RP2.PC**.

The yellow Test Button does not have any function associated with PC Mode.

SETUP MODE (ALL MODELS)

```

NORMAL
DRILL
PC
SETUP

```

SETUP Mode provides access to a variety of calibration routines, user interface settings, and personal preferences. It consists of 2 pages. We recommend that you write these settings down. When you update the firmware or restore factory defaults, these settings will be erased. Writing them down will save time if you need to re-enter the values.

```

CONTRAST 15
HAND RIGHT
LANGUAGE EN
OSC CALIB 25↓

```

CONTRAST adjusts the contrast of the screen to improve visibility under a variety of lighting conditions. The range is from 00 to 30. Default setting is 15, which should work best for most lighting conditions. However, if so desired, the user can lighten or darken the screen by changing the value. Going down in value provides a lighter screen; whereas, going up in value darkens the screen.

If this setting is changed to either extreme value, it may appear that the screen is completely dark or that no information is displayed. But by adjusting your viewing angle and/or the amount of light hitting the screen, you may see faint outlines of letters and/or numbers. Adjust the value accordingly to make the screen more readable.

```

CONTRAST 15
HAND RIGHT
LANGUAGE EN
OSC CALIB 25↓

```

HAND is one of the unique features of the digital Robo-Pong robots. It lets the user select their dominant hand so that drills run correctly with regards to backhand/forehand strokes. Values are Right (default) or Left. Select the one that matches your dominant playing hand.

Since drills are normally written for right-handed players, who are the vast majority of players, this switch allows a left-handed player to use drills written for a right-handed player without needing to rewrite the drill. We recommend that all drills be written for right-handed players so that this switch works properly.

HAND only affects drills run from either **DRILL Mode** or directly from your PC in **PC Mode**. It has no effect on **NORMAL Mode**.

CONTRAST	15
HAND	RIGHT
LANGUAGE	EN
OSC CALIB	25↓

LANGUAGE allows selection of the desired language for displaying the menu system and messages. Values are EN (English), DE (German), FR (French), ES (Spanish), CN (Chinese), or JP (Japanese). EN is the default. After selecting the desired language, any press of another button will activate that language and all information displayed on the LCD screen will be shown in that language.

If the menu system is displayed in a language that cannot be read, another language can be chosen by using the Language Selection Special Function (see page 13).

CONTRAST	15
HAND	RIGHT
LANGUAGE	EN
OSC CALIB	25↓

OSC CALIB is used to calibrate a position setting of 10 with the centerline of your table tennis table (see page 7 for explanation of positions). Once position 10 is calibrated to the centerline, all other positions will be properly calibrated as well. Range of values is from 00 to 50. Default is set to 25.

Decreasing the value results in the ball's landing spot shifting toward the left and increasing the value results in it shifting to the right. To see if your oscillation needs calibrating, set the Spin to Topspin and the Head Angle to 8. Then press the yellow Test Button once.

5 Balls will be shot out from the robot. Carefully observe the landing spots of these 5 balls in relation to the centerline. If the balls land in a cluster around the centerline, no adjustment is necessary. However, if the 5 balls cluster consistently to the right of the centerline, decrease OSC CALIB until the 5 balls cluster around the centerline. Similarly, increase OSC CALIB if the test balls consistently land to the left of the centerline.

It is normal for balls to land slightly to the left or right of the centerline, but of the 5 test balls thrown, there should be roughly equal numbers that are thrown left or right of the centerline. If balls are always thrown either on the centerline or to the right, for example, go ahead and decrease OSC CALIB to shift the cluster slightly to the left.

Before changing OSC CALIB, check to be sure the robot is properly centered on the end of the table. The center support rib of the triangular shaped Front Support Plate (Key #5 on page 44) should align with the centerline of the table.

SENSOR CALIB	10↑
ALARM CALIB	10
SPEED CALIB	10
255	255 255

SENSOR CALIB corrects poor ball feed performance. Be cautious about changing this from the default value until you have eliminated other causes, discussed below.

The Ball Sensor (#40, Figure H, page 45) detects when a ball should be thrown out and is responsible for accurate ball counting. If your robot begins to throw 2 balls at once, doesn't throw out a ball when it is supposed to, or seems to often hesitate immediately before a ball throw, you may need to calibrate the Ball Sensor.

Values range from 00 to 20 with 10 being the default value. Decreasing the value advances a ball's position in the ball channel so the ball is sensed "earlier". Increasing the value causes the ball to be sensed "later".

You would decrease the value if the robot doesn't throw a ball out when it's supposed to or seems to often hesitate immediately before ball throws. Increase the value if you often get two balls thrown instead of 1 ball.

Before adjusting SENSOR CALIB, please eliminate other more likely causes. It is normal for an occasional hesitation before a ball throw, but this should not happen on regular basis. This is caused by the pickup mechanism missing a ball pickup and rapidly accelerating the feed wheel to "make up" for the missed pickup. There will be a slight hesitation before the ball feed mechanism can "catch up" after a missed pickup. Also if the chip loosens from its chip holder, the Ball Sensor will not work.

A common cause of missed ball pickups is that there are not enough balls immediately in front of the ball pickup mechanism. Add more balls to your robot to prevent this. If several balls are not in contact with the Pickup Fingers (#46, Figure I, page 43), they cannot be picked up. This mimics incorrect ball sensor calibration, but the true cause is simply there are not enough balls for the pickup mechanism to work properly or something is preventing balls from rolling down into the pickup mechanism.

Something else that can cause the ball sensor to not sense balls correctly is that the steel lever attached to the sensor does not protrude far enough into the ball channel. The lever needs to protrude far enough into the channel that a ball cannot pass by it without activating the sensor (you should hear a clicking sound as the lever is depressed). If necessary, carefully bend this lever inward so it detects balls properly.

Undersized balls may also cause this behavior. Please verify that all balls are 40mm in diameter (see page 17 for using a Ball Dam² to check ball diameters). Robo-Pong 2055 and 1055 cannot utilize 38mm balls.

Lastly, something that causes double ball throws is a broken Ball Discharge Spring (#58, Fig. D, pg. 44). If this part is broken, missing, or deformed, it is likely the culprit and should be replaced before adjusting SENSOR CALIB. Forcing the head angle to less than 1 can also cause this.

If you have eliminated other more likely causes, adjust SENSOR CALIB by setting the head to Backspin and to Angle 7. Then press the yellow Test Button. The robot will begin shooting balls into the table net and the balls will roll back into the net system. If balls aren't being thrown into the table net, adjust the Head Angle until they are.

Balls will be delivered to positions 12 and 16. Watch the head carefully to be sure that one and only one ball is thrown out each time the head completes its sideways travel. It likely will take numerous balls to be thrown before a problem is detected. Press any button to stop the test. If SENSOR CALIB needs adjusting, select a new value and then repeat the test until the problem disappears.

SENSOR CALIB	10↑
ALARM CALIB	10
SPEED CALIB	10
255 255 255	

ALARM CALIB effects the sensitivity of the Ball Jam Alarm. This alarm is activated whenever the resistance of the Ball Feed Motor rises above a preset level. This causes the alarm to sound and power to the Ball Feed Motor is cut until the problem is resolved. This prevents damage to the Ball Feed gears and other parts. For most users, this feature will never be needed and should be kept at default value.

Dirty, broken, or oversized balls are the most likely causes for this alarm to activate. Other causes are foreign objects or anything else that would prevent balls from being pushed smoothly through the ball channel.

The alarm has a range of adjustment to allow the user to make it activate sooner or later than "normal". The range is from 0 to 20 with 10 being the default value. If you desire more sensitivity, you can increase the value. If you want less sensitivity, decrease the value.

A likely scenario where you may consider decreasing the sensitivity would be if the balls get very dirty and the alarm starts activating. Instead of stopping and washing the dirt off the balls, the user wants to continue playing with dirty balls. Although not guaranteed, decreasing **ALARM CALIB** may allow dirty balls to be used until such time that they can be properly cleaned.

SENSOR CALIB	10↑
ALARM CALIB	10
SPEED CALIB	10
255 255 255	

SPEED CALIB is used to fine tune the BALL SPEED. For drills that have been created on a different Robo-Pong to work correctly on your robot, it is important that BALL SPEEDS on the two machines be calibrated so that a value of, for instance 15, results in the same landing spot on both robots. This problem would most likely be caused by components wearing or aging.

Values range from 0 to 20 with 10 being default value. Increasing the value results in more speed being added to the ball; decreasing the value, in less speed. However, there is an upper limit to this effect—no balls set at BALL SPEED 25 or higher will be affected by **SPEED CALIB**. So don't think that increasing this value will result in faster top speeds. BALL SPEED 30 is already set at the maximum for the motor and the electronics controlling that motor. So setting **SPEED CALIB** to 20 and using a BALL SPEED of 30 would not result in even more speed being applied to the ball. As a matter of fact, it would cause the robot to run worse, possibly resulting in an over-voltage situation where power is cut off to the Control Box and causing it to reset.

SPEED CALIB should only be used as a last resort when all other possible solutions do not resolve the problem. The first thing you should check if balls are not landing where they should, is to check that the robot is level

and the Head Angle is set properly.

As discussed previously, the Head Angle Adjustment Mechanism is not precise, so a Head Angle Setting should be used as a general guideline, not as an absolute. In general, for any given head angle, the acceptable tolerance is ± 0.25 . So if the given Head Angle is 8, the acceptable range for that setting is 7.75 to 8.25. Many times, speed "problems" can be resolved simply by adjusting the head angle.

Another common cause of slower ball speeds is that the rubber Discharge Wheel and/or Friction Block are dirty. Dirt buildup on these two parts can cause a substantial reduction in ball speeds. Clean these parts regularly to maintain top speeds. See page 37 for recommended cleaning procedures.

To use **SPEED CALIB**, make a 6 x 6 inch paper target. One is provided on page 27, but instead of cutting that target out, we recommend making a copy and using the copy. Then follow the instructions as given on the target.

SPECIAL FUNCTIONS (ALL MODELS)

There are 4 special functions that can be accessed by pressing a combination of buttons on the Control Box: (1) Language Selection, (2) Ball Unloading, (3) Self Diagnostics, and (4) Factory Default Restoration. All special functions begin by pressing and holding the OK/Menu Button until the screen goes blank. Release the OK/Menu Button and after a brief moment, the screen turns completely black. Then press one of the gray arrow-shaped buttons as given in the following descriptions:

Language Selection is particularly useful if the menu system is displayed in a language that the user cannot read. Press and hold the OK/Menu Button until the screen goes blank and then release. Momentarily, the screen turns completely black. Now press *and hold* the Up Button. The following message appears in the currently selected language:

RELEASE BUTTON WHEN YOU SEE YOUR LANGUAGE

It will then begin cycling through all the languages, one at a time, with a short pause before each one. When you see the language you prefer, let go of the Up Button and the menus will stay in that language. Press any button to exit Special Functions mode and resume normal operations.

Ball Unloading is used when you want to quickly empty balls out of the robot's trays² or bucket¹. This is typically done when the user wants to practice serves by gathering all balls from the robot and placing them into a bin.

Before using this function, get a medium-sized plastic bin (available at many department & hardware stores). If you have a Robo-Caddy, it's convenient if the plastic bin is sized to fit into the caddy's tray.

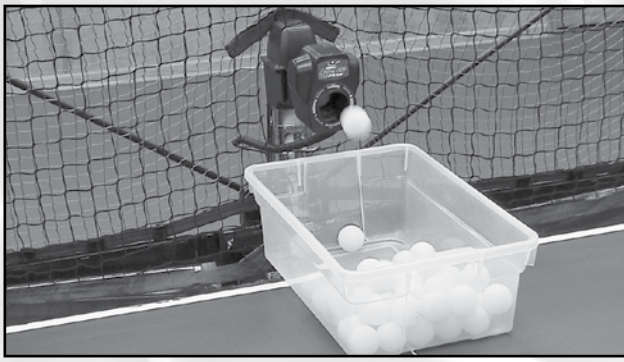

Place the plastic bin under the robot's head. Then press and hold the OK/Menu Button until the screen goes blank and then release. After the screen turns completely black, press the Down Button. The following message appears:

BALL UNLOADING
PLACE TRAY UNDER
ROBOT HEAD

In a moment, balls will start dropping out of the robot's head at maximum frequency, landing in the plastic bin placed underneath. In a short amount of time, all balls will be pulled from the trays² or bucket¹ and deposited into the bin. Place the bin on the top of the table or into the top of the Robo-Caddy on the server's end of the table. Now practice your serves and use the robot's net system to capture and collect your serves:

Self Diagnostics is used to help troubleshoot the robot when having problems with the robot. This should be used principally with a trained service technician who can properly interpret the codes provided. Always perform a Factory Default Restoration (described next) before using Self Diagnostics.

To activate, use the same routine described previously for making the screen go black. Then press the + Button. The screen will display the following message and then generate a series of numbers in the last line:

TESTING SYSTEM
GIVE ERROR #S
TO TECHNICIAN
0123456789

Write down these numbers and give them to a service technician. These codes may assist the technician with troubleshooting the problem.

Factory Default Restoration is handy when you suspect that a setting may be causing the robot to behave in a strange manner. Restoring all settings to factory default means that all values are set back to the default value for each function. This is a handy step to take when you suspect that the robot is malfunctioning and should always be done before calling for service help. It may clear up the problem by itself.

Please remember to recalibrate your robot after using Factory Default Restoration as any custom setting is

overwritten during this procedure. As mentioned previously, it is handy to write down all values for functions in the SETUP Mode, so you can quickly reenter them after you use Factory Default Restoration. We have included a space on the back cover to record your settings.

Like the other Special Functions, begin by holding down the OK/Menu button until the screen goes blank and then release that button. When the screen turns all black, press the – Button. You will then see the following screen:

RESTORING
FACTORY
DEFAULTS

And after a moment, the screen will confirm that the procedure completed successfully:

FACTORY
DEFAULTS
RESTORED

A few seconds later, the above screen disappears and the system reboots and you are taken automatically to page 1 of the default Normal Mode.

BALL TRAJECTORY (ALL MODELS)

The trajectory of a ball is regulated by adjusting the angle of the robot head. The angle can be changed from low to high. At its lowest setting (1), the ball will be delivered so it first strikes the robot's side of the table, bounces over the net, and lands on the player's side of the table (just like a serve). At its highest setting (13), the ball will be delivered in a high arc over the net (like a lob return).

The trajectory is adjusted by tilting the head up or down. If the head will not tilt, loosen the Brass Knob on the right side of the robot head. If the head does not stay at the desired angle, tighten the Brass Knob slightly (see Figure 3). For reference, there are head angle indicators next to the Brass Knob numbered 1 to 13 (see Figure 4). These

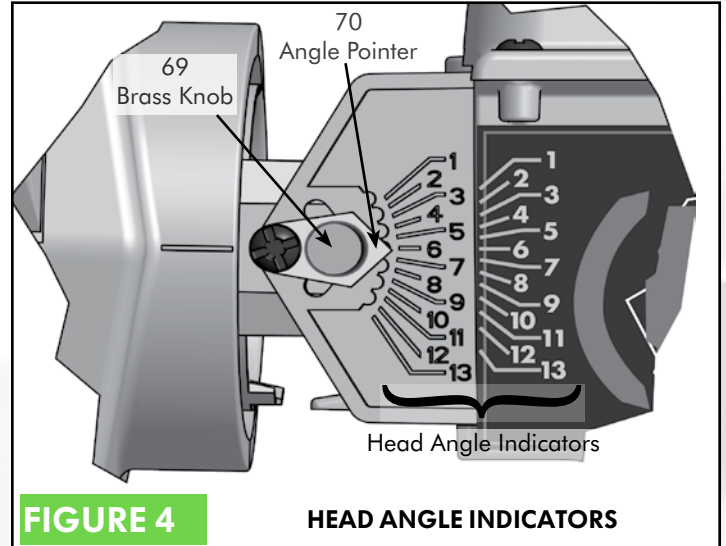
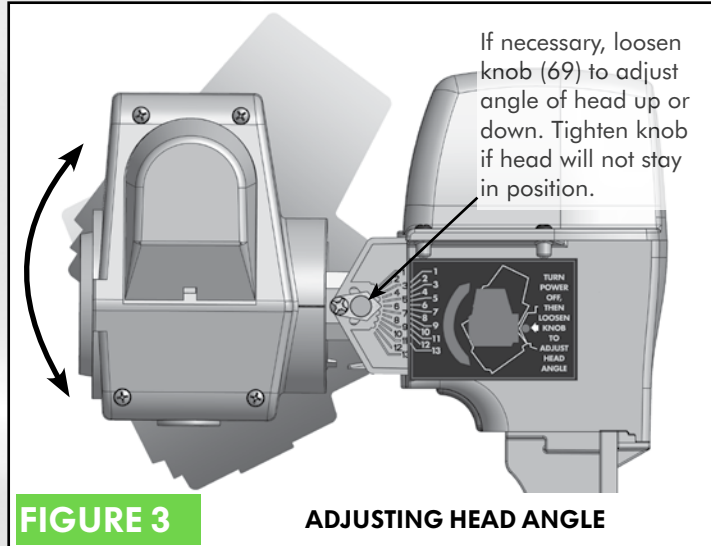

indicators are not precise, so you may need to nudge the head slightly up or down from a setting when a particular head angle is provided.

WARNING: DO NOT adjust the head angle when the head is moving side to side. Failure to follow these instructions may result in broken parts and may void your warranty.

BALL SPEED directly influences the ball trajectory setting. When the head is set so the ball first strikes the **robot's** side of the table (robot "serving"—see Figures 5C & 5D), maximum BALL SPEED is in the range of 10–15. As BALL SPEED is increased, the head must be angled up to deliver the ball so it first strikes the **player's** side of the table (robot "returning"—see Figures 5A & 5B). As BALL SPEED is increased even more, adjust the head angle down to prevent the ball from being thrown off the end of the table.

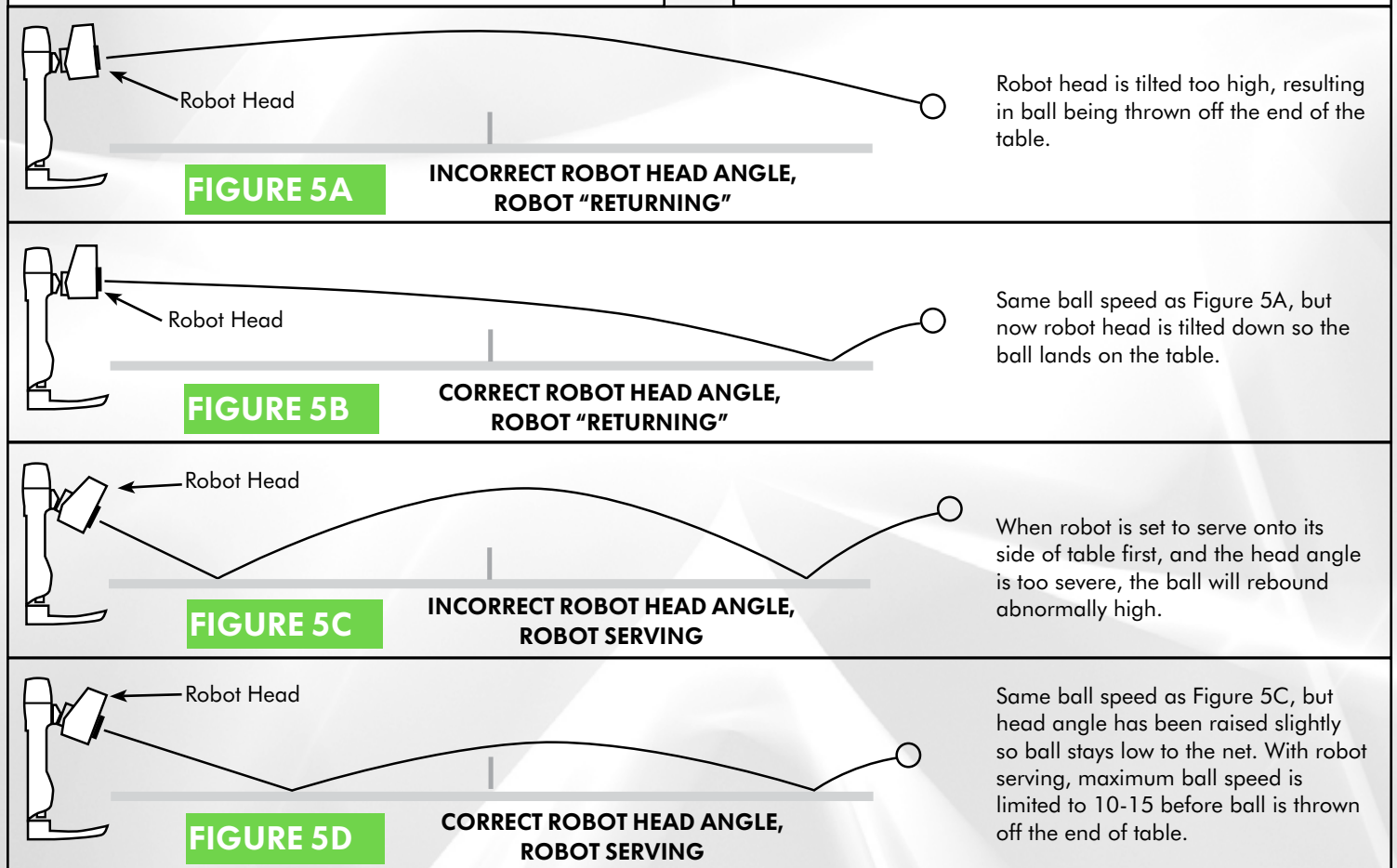

BALL SPIN (ALL MODELS)

Robo-Pong robots are capable of putting any type of spin on the ball. Topspin, backspin, sidespin, and even combination spins can easily be selected. To change the spin, simply rotate the head of the robot until the desired spin is at the top of the Ball Discharge Hole (see Figure 6).

For combination spins, move the head until one of the rotational arrows is at the top of the Ball Discharge Hole. For instance, if the arrow between Topspin and R. Sidespin is selected, the robot will deliver a ball containing both topspin and right sidespin. Likewise, if the arrow between Backspin and L. Sidespin is selected, the robot will deliver a combination backspin/left sidespin ball.

Before discussing how to return spins, it's important to know that your robot simulates the play of a modern table tennis professional using inverted sponge rubber. With Robo-Pong robots, there is always some kind of spin on the ball. To learn how to produce your own spin and return an opponent's (or the robot's) spin, it is important to use the correct equipment—a quality inverted or pips out sponge rubber racket. Using old-style paddles such as hard rubber or sandpaper will make it more difficult to control spin.

Each spin has a different effect on the ball and how the ball reacts when you strike it with your paddle. Following are some brief pointers to help you return the different spins. More detail is available in the NEWGY ROBO-PONG TRAINING MANUAL which is included with your robot if bought in the U.S., or as a download from Newgy.com.

The secret to returning spin is to angle your paddle correctly when contacting the ball. Any spin can easily be returned if you angle your paddle properly. Set your paddle angle at the beginning of your stroke and maintain the same angle until your stroke ends. Avoid changing your paddle angle during your stroke (see Figure 7).

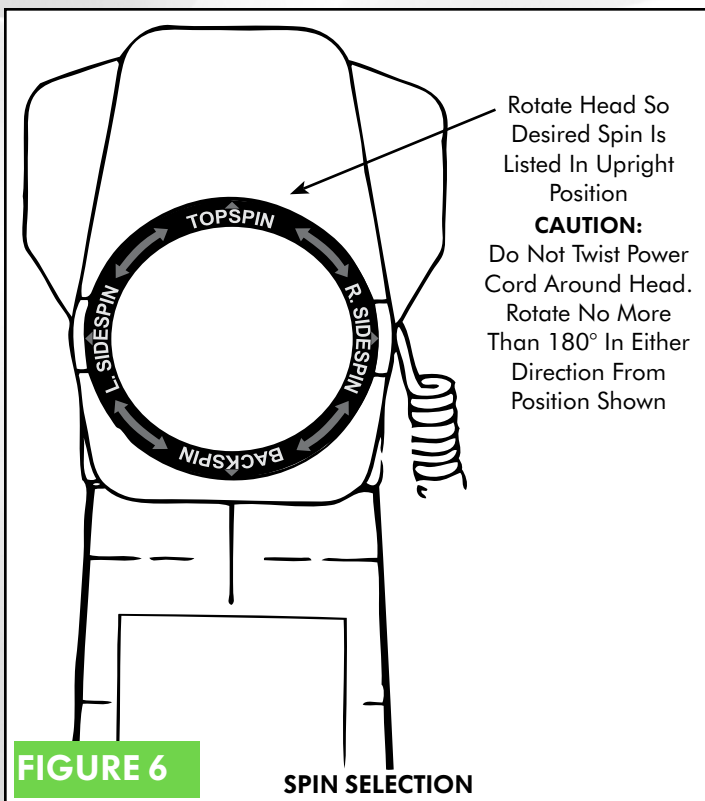

Topspin causes the ball to dip downward as it travels through the air. When you strike the ball with your paddle, it has a tendency to pop up high in the air. To compensate for topspin, angle your paddle face down as you stroke through the ball in a forward and upward direction. Contact the top surface of the ball (see Figure 7A).

Backspin causes the ball to rise upward and float as it travels through the air. When you strike the ball with your paddle, it has a tendency to go straight down into the table. To compensate for backspin, angle your paddle face upward as you push your paddle straight forward. Contact the bottom surface of the ball (see Figure 7B).

Sidespin makes the ball curve sideways through the air. Left sidespin makes the ball rebound off your paddle to your right; right sidespin to the left. To compensate for left sidespin, angle the paddle face to the left and contact the right side of the ball. To compensate for right sidespin, angle your paddle face to the right and contact the left surface of the ball (see Figures 7C & 7D).

Combination spins take on the characteristics of both spins, although to a lesser degree than the pure spins. To compensate for topspin/right sidespin, you must angle your paddle face down *and* to the right and contact the top left surface of the ball. Likewise, a backspin/left sidespin ball is best returned by angling your paddle face up *and* to the left and contacting the ball on its bottom right surface.

Spins are intensified by increasing the Ball Speed (see page 7). You intensify both speed and spin every time you turn up BALL SPEED. It is not possible to adjust Robo-Pong robots to deliver a slow ball with lots of spin, for instance. It is also impossible for Robo-Pong robots to deliver a no-spin ball. Additionally, since backspin causes the ball to rise, the maximum setting for BALL SPEED when the robot is set on Backspin is approximately 15–17.

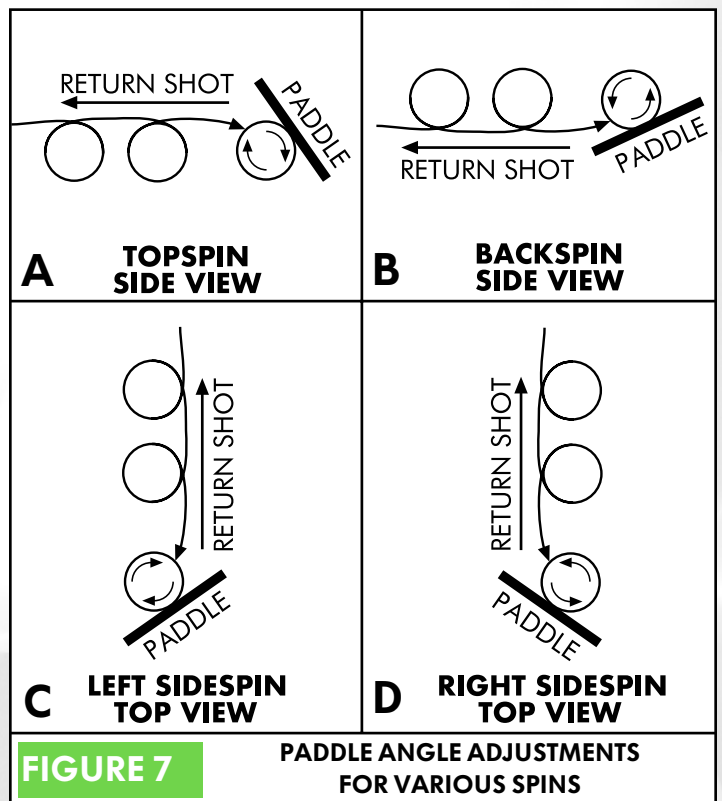

BALL DAMS (2055 ONLY)

Robo-Pong 2055 comes with a pair of Ball Dams. They serve three functions: (1) they keep balls inside the Center Trough when the robot is folded up, (2) they keep balls from entering the Center Trough when you want to remove the robot body, and (3) they serve as a ball gauge for determining if a ball is the proper size and whether it should be used in the robot.

The Ball Dams, when used for functions 1 or 2, fit into two retaining slots at the top of the Center Trough. When not in use, the Ball Dams fit into their storage slots on the side of the Center Trough (see Figure 8).

To use the Ball Dams when preparing the robot for storage or transport, remove the Ball Dams from their storage slots by pulling slightly up on the trays to reveal the storage slots (see Figure 10). Then push all the balls into the Center Trough and insert the Ball Dams into their retaining slots (see Figure 9). To use the Ball Dams for function #2, push the balls up into one of the Ball Return Trays and quickly insert the Ball Dam into its retaining slot before the balls can roll down into the Center Trough. The balls will be out of the way and you can easily loosen the two wing nuts and two clip washers, then pull up on the robot body to remove it.

The hole in a Ball Dam serves as a handy ball checking feature. The hole is exactly 40.6mm in diameter, which is the largest allowable size for a table tennis ball. Robo-Pong 1055 and 2055 can use only 40mm or 40+mm balls. Do not use 38mm, 44mm, or any other ball size than 40mm or 40+mm. Do not mix 40mm and 40+mm size balls. Use the hole to test the roundness and size of balls used in the robot.

If you suspect a ball is out of round or too large, as indicated by balls jamming within the robot, insert the suspect ball into the ball checker hole. With your fingers, rotate it around inside the hole to check all possible diameters of the ball. The ball should have equal clearance through the hole on all diameters. The ball should fit through the hole without binding. It is also possible that a ball is too small. In this case, you will notice a considerable gap between the ball and the edge of the hole.

Note: Be aware that plastic balls (also called poly balls) are identified with the marking 40+. They were introduced in 2014 and are approximately 0.5mm larger in diameter than the average celluloid ball (40mm), which is the material that has historically been used for table tennis balls. Plastic balls are marked with 40+ instead of 40 that is used on celluloid balls. When using the ball checker hole, there should be considerable more gap when measuring celluloid balls than when measuring plastic balls.

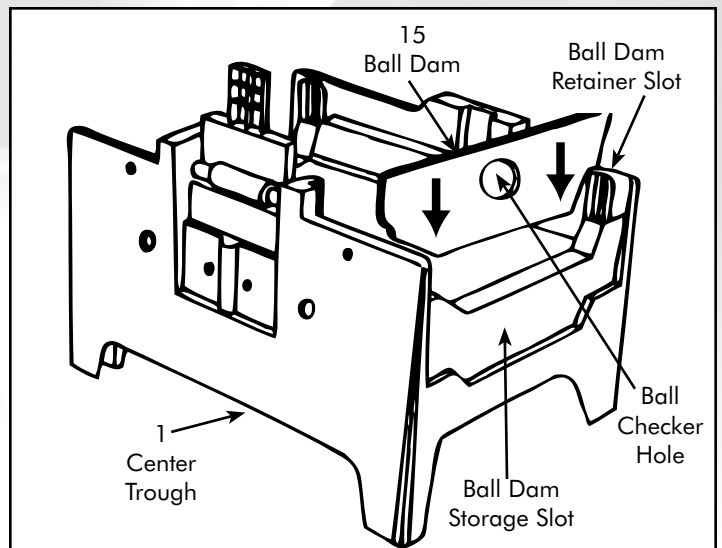

FIGURE 8

BALL DAM & CENTER TROUGH
(2055 ONLY)

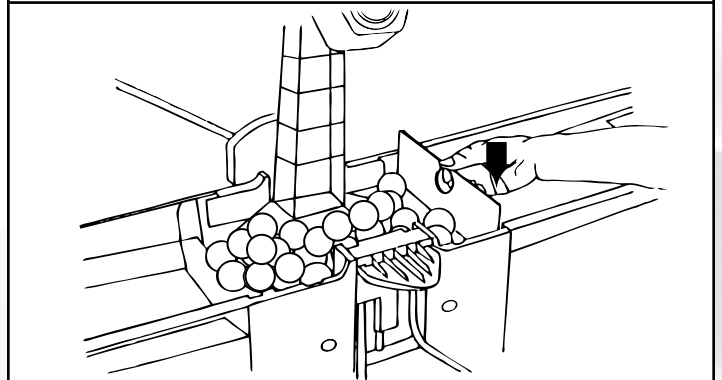

FIGURE 9

INSERTING BALL DAM
(2055 ONLY)

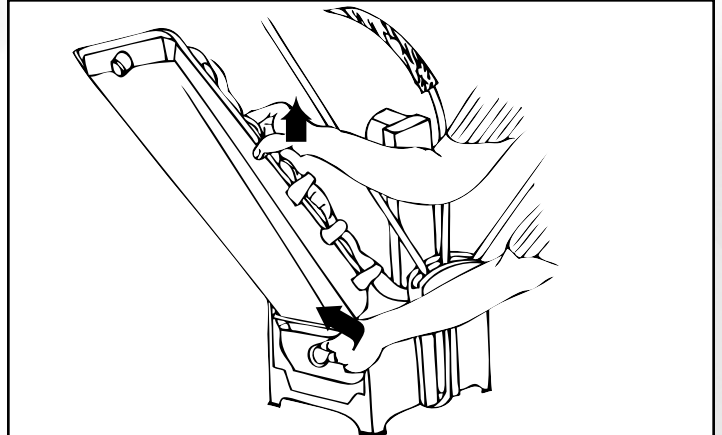
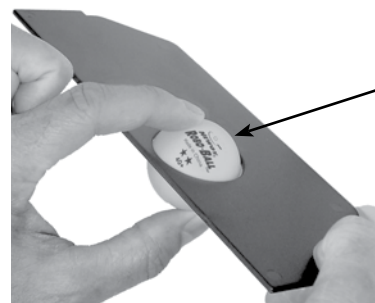

FIGURE 10

REMOVING BALL DAM
(2055 ONLY)



Rotate Ball Inside Hole To Check All Diameters Of The Ball. Ball Should Pass Easily Through Hole On All Diameters.

FIGURE 11

CHECKING BALL WITH BALL DAM
(2055 ONLY)

POSITIONING YOUR ROBOT AND CONTROLS (ALL MODELS)

Robo-Pong robots are versatile in how they are positioned in relation to the table. The 1055 normally sits on top of the table as shown in robot positions 1–4 in Figure 12. They can also be mounted in the optional Robo-Caddy and placed behind the table like positions 5 & 6. The 2055 is typically mounted to the end of the table at position 5, but can alternatively be mounted in the Robo-Caddy just like the 1055.

Some positions offer certain advantages while other positions compromise some of the robot's functions. By placing the robot in various positions you can achieve a variety of angles and trajectories to simulate almost any type of shot you would encounter in a regular game. The following paragraphs explain this further.

Position 1—Robot positioned square to the table where the centerline and endline of the table meet. This is the only *on the table* position in which the 1055's oscillator positions will be accurate (see Figure 2, page 7). Also, this is the desired starting position when first setting up the 1055.

Position 2—Robot positioned at the far left corner and angled cross-court. This position will skew the 1055's oscillator positions toward the player's right side of the table. This position would be the preferred direction when simulating typical right-handers' forehand to forehand rallies.

Position 3—Robot positioned at the far right corner and angled cross-court. Setting the robot in this position will skew the 1055's oscillator positions toward the player's left side of the table. Typical backhand to backhand play for right-handers would be ideally simulated with the robot in this position.

Position 4—A robot placed in this position has the advantage of offering slower and faster ball speeds because it is closer to the landing spot of the ball. At a Ball Speed setting of 1, the ball is very slow and with light spin, but is delivered deep on the player's end. At a Ball Speed setting of 30, the ball speed is very fast and simulates the angle from which a typical kill shot would be hit. However, the 1055's oscillator range is narrower than if the robot had been positioned at the endline like Positions 1–3. This position also is similar to the ball release point that most coaches use when doing multi-ball drills with a student.

Position 5—This is the normal position of the 2055 when it is attached to the end of the table, and its net system would function normally. The 1055 would have to be mounted in the Robo-Caddy to be in this position. Positioned here, the 2055's and 1055's oscillator ranges would be accurate.

Position 6—Mounted in a Robo-Caddy, both models can be freely moved around in back of the table. The Robo-Caddy also permits lowering or raising the height of the robot. This is great for simulating deep shots such as chops, lobs and loops. However, the oscillator ranges for the 1055 and 2055 are not accurate and the 2055's net system is usually not effective at capturing balls when in this position. Additionally, you need to purchase a Shielded Connector Extension Cable to extend the length of the Connector Cable from 11 to 22 feet. This permits the Control Box to stay within reach of the player.

These positions are only a few of the ones possible, but they will give you a good idea of the pluses and minuses of placing the robot in a particular position.

IMPORTANT NOTE: *Even though the oscillator range may not be accurate as described in Figure 2 on page 7 when the robot is in certain positions, you should be able, with experimentation, to find the correct settings to permit ball delivery over any particular part of the table.*

Figure 12 also illustrates the ideal positions for the Control Box. If you're right-handed, Position A is the preferred location for the controls. If you're left-handed, Position B is preferred. Locating the controls in these suggested positions permits the controls to stay within easy reach of the player's free hand.

Since a player has a longer reach on the forehand side, it is suggested that you position your body as shown. The overwhelming majority of tournament level players use their backhand to cover about one-third of the table and their forehand to cover the other two-thirds of the table.

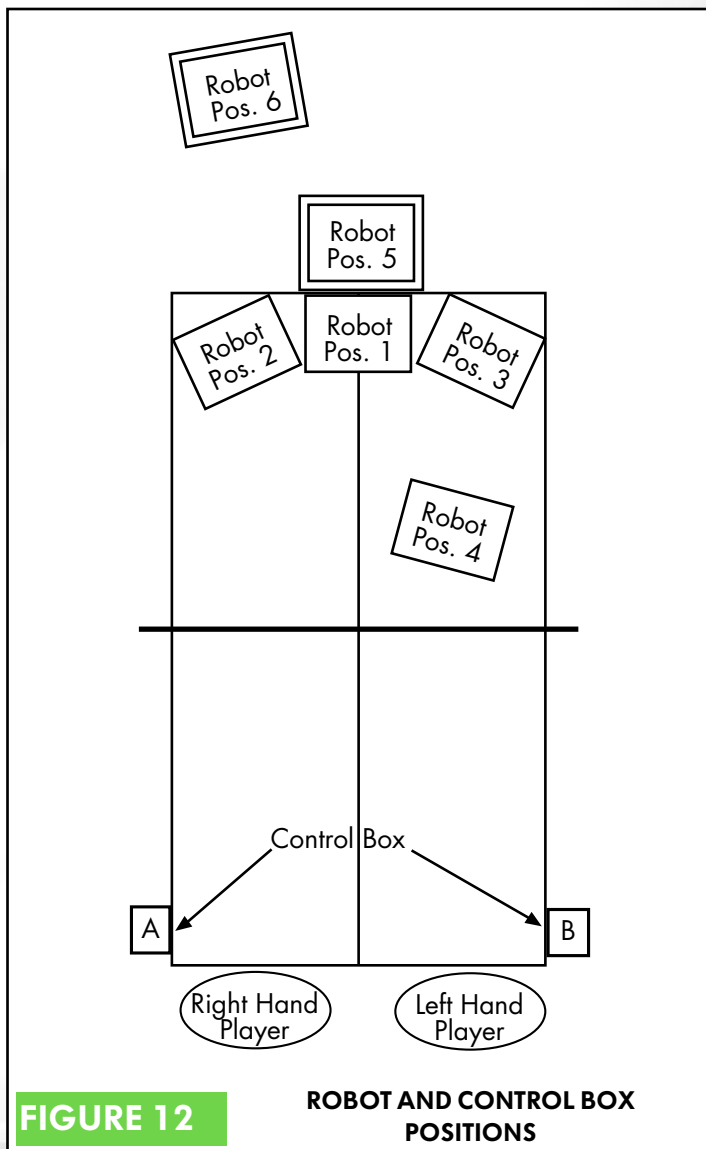

MISCELLANEOUS ADJUSTMENTS (2055 ONLY)

LEVELING ADJUSTMENT (2055 ONLY)

Robo-Pong 2055 is designed to sit level when attached to the table. In proper position (Figure 13), the CT Support Legs fit underneath the table and the CT Front Support Plate sits on top of the table. If the robot does not sit level, balls will not feed properly. If this condition occurs, it is necessary to make some leveling adjustments. The first adjustment is to level the table top by placing shims under the table legs until the table top is level.

If this does not cause the robot to sit level, then it will be necessary to make adjustments to the robot itself. The Support Legs come with 3 sizes of Rubber Tips and 4 rubber spacer-washers to accommodate different table top thicknesses, and cause the Center Trough to sit level. The Rubber Tips are marked on their top with the table thickness they are used with. The longest is used for $\frac{1}{2}$ " (13mm) tops. The mid-size one is used on $\frac{3}{4}$ " (19mm) tops and comes pre-installed. The shortest tip is used for 1" (25mm) tops.

In addition to these different sized tips, there are 4 rubber spacer-washers which are used with the Rubber Tips for finer adjustments. Either one or two of these spacer-washers (depending on how much adjustment you need) are placed inside the Rubber Tips before the tips are placed on the end of the Support Legs.

Another reason why your robot may not sit level is that it is not properly seated on the locating tab. When seated correctly, the Support Flange of the Back Panel sits flush on the Locating Tab that protrudes from the top of the Center Trough or Ball Bucket (see Figure 14). Your robot serial number is located on top of this Support Flange.

TIP: If it is possible to adjust the level of the robot's half of the table independently from the player's half, you may choose to purposely give a slight slope to the robot's half so balls that end up on the table roll into the robot's trays. If you make the table unlevel, make sure the robot sits level by adjusting the Rubber Tips as described above. In this case, it may be necessary to use the Rubber Tip one size larger than normal and/or the rubber spacer washers to level the robot.

ADJUSTING NET TENSION (2055 ONLY)

The Ball Return Trays should sit level at or just below the level of your table top. If the tension of the Main Net is too tight, the trays will be pulled up into a slight "V" shape with the top edge of the trays above the level of the table top. To correct this situation, loosen the adjustment straps shown in Figure 15 until the trays sit level. If this adjustment is insufficient, stretch the net by grabbing it with two hands and pulling gently apart to relax the net fabric.

The Trap Net (the black net with large holes) slows down your returns so more of them are captured. The size of the holes is slightly smaller than the diameter of a ball. Hard hit shots force the ball through the net and the ball becomes trapped between the Trap Net and the Main Net. When slowly hit balls contact the Trap Net, they do not have enough force to go through the net, so they immediately drop down into the trays.

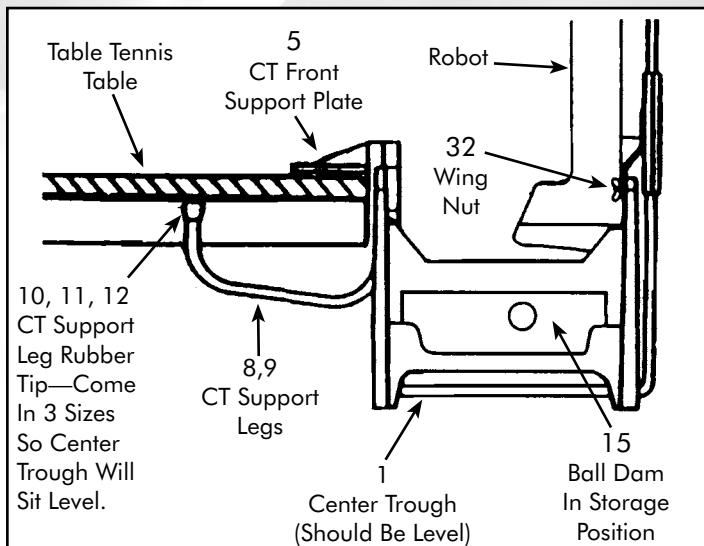

FIGURE 13

CENTER TROUGH ATTACHMENT (2055 ONLY)

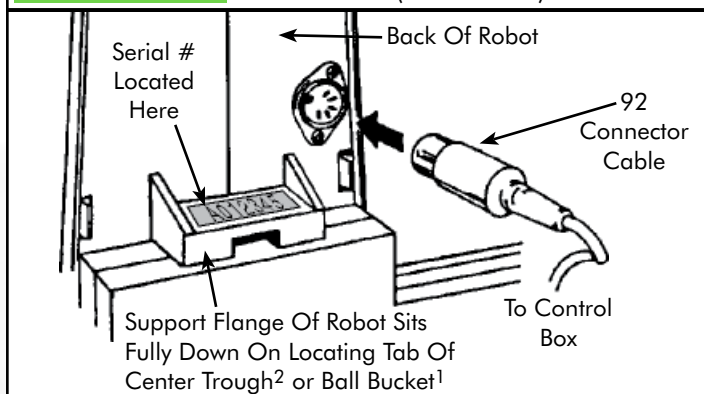

FIGURE 14

SUPPORT FLANGE ALIGNMENT & SERIAL # (2055 ONLY)

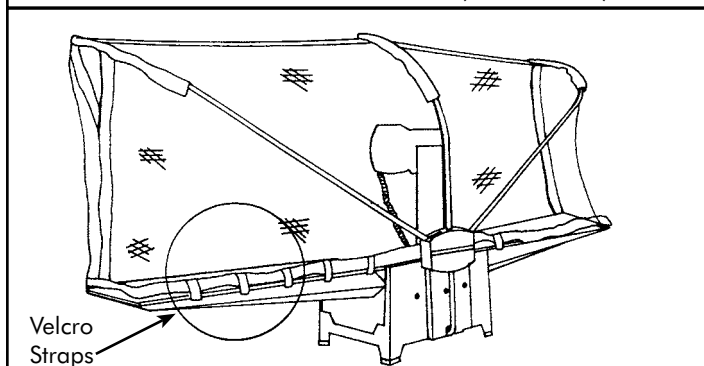

FIGURE 15

ADJUSTING MAIN NET TENSION (2055 ONLY)

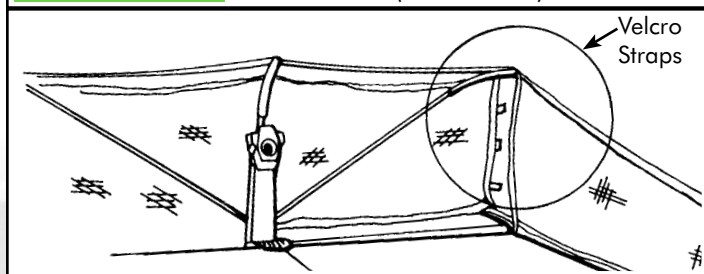

FIGURE 16

ADJUSTING TRAP NET TENSION (2055 ONLY)

The Trap Net is normally hung loosely to increase its energy-absorbing capability. If you are practicing hard hit shots like smashes or fast loops, you may find that a tighter Trap Net captures more of your shots. The tension of the Trap Net is adjusted by tightening or loosening the velcro straps at the sides of the Trap Net (see Figure 16).

Side Nets block off the sides of the table and direct wide angled shots into the main net. The Side Nets have a red flexible band sewn at the narrow end of the net. This flexible band is used to attach the Side Net to either the clamp assembly for the table's net (the net that separates the two halves of the table—see Figure 17) or to a clip that is attached to the table surface (see Figure 18C). Furthermore, you can adjust the tension of the Side Nets by modifying the flexible bands (see Figures 18B and 18E).

If the table net has a clamp screw, pass the flexible band of the Side Net over the *top* of the net support and wrap it around the clamp screw as shown in Figure 17.

If your table net does *not* have a clamp screw, use the Plastic Clips included with your robot. Clean the table surface with isopropyl alcohol along the sideline about 1–3 inches before the table net. After the alcohol dries, remove the backing on the bottom of a clip and press it onto the table top along the sideline about an inch from the net. The open end of the clip should face away from the robot (18A). Create a knot close to the centerpoint of the flexible band (18B). Insert the band into the clip where the knot is located (18C). Side Net should look like 18D.

The flexible bands were designed to provide the proper tension for the side nets in most installations. If you require more tension to hold the side nets in place, then simply knot the band as shown in 18B to shorten the band length and then reattach. Be careful to never use so much tension that you pull the main net with sufficient force that the Ball Return Trays are lifted up. If you need less tension, then you can lengthen the band by tying a hair band of the required size (available at many stores) to the side net's flexible band (see Figure 18E).

When first used, the netting material is *taut*. The material will *relax* over time by itself. If there is sufficient gap between the bottom of the side net and the table surface that a ball can roll through that gap, then you should manually *relax* the net.

Figure 19A illustrates this problem. Even though the Side Net has been installed correctly, the bottom of the Side Net is too high, allowing a ball to roll underneath it. To correct, gently stretch the netting material directly above the problem area until it relaxes enough to where the bottom edge of the net is just above the table surface (see Figure 19B).

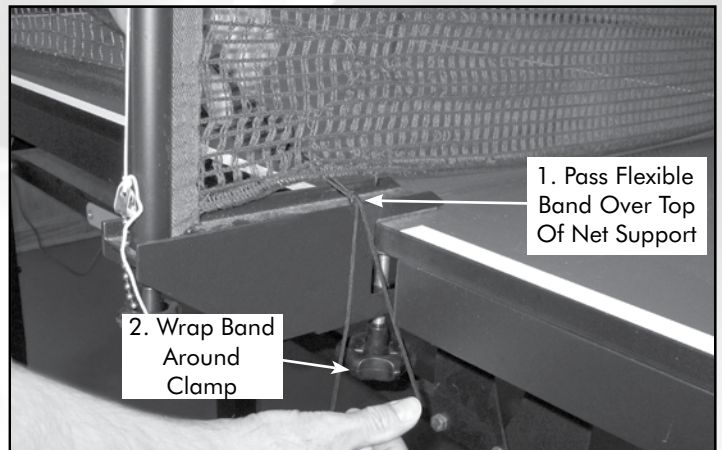

FIGURE 17 ATTACHING SIDE NET TO CLAMP FOR TABLE NET (2055 ONLY)

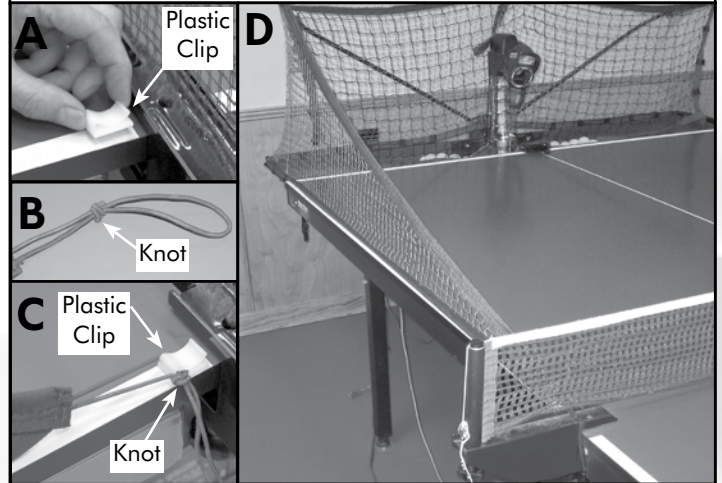

FIGURE 18 ATTACHING SIDE NET WITH PLASTIC CLIPS (2055 ONLY)

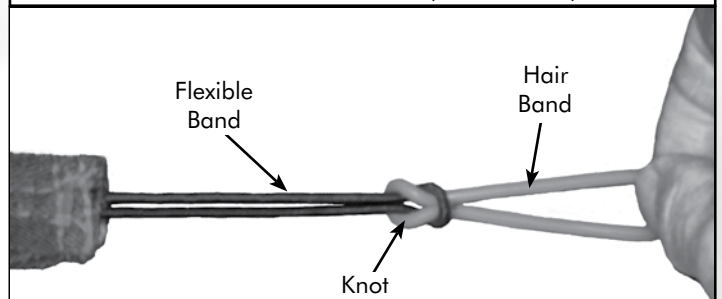

FIGURE 18E LENGTHENING SIDE NET TO REDUCE TENSION (2055 ONLY)

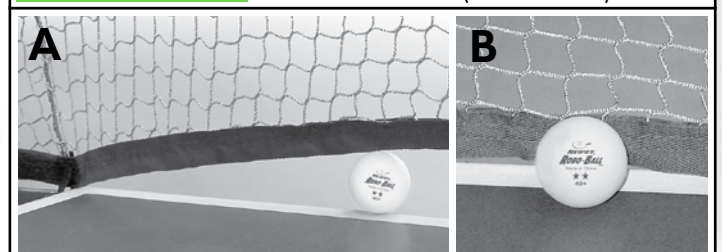

FIGURE 19 IMPROPER/PROPER GAP FOR SIDE NET (2055 ONLY)

DRILL DIAGRAMS (ALL MODELS)

Please read the DRILL MODE section (*page 9*) for a quick explanation about how to access the 64 drills that come pre-installed with your robot. Also that section explains how the drills are adjusted from within the Drill Mode menu.

Drills are grouped in the following order to help in locating a drill for training a certain level of player or particular aspect of table tennis:

Drill #'s	Description
01–05	Beginner Player Drills
06–15	Intermediate Player Drills
16–20	Serve Return Drills
21–25	Backspin Drills
26–30	Randomization Drills
31–32	High Ball Drills
33–40	Figure Drills
41–45	Letter Drills
46–50	Novice Progressive Drills
51–55	Intermediate Progressive Drills
56–60	Advanced Player Drills
61–64	Expert Player Drills

The first 32 drills (drill #'s 01–32) are locked and cannot be overwritten by the user. The last 32 drills (drill #'s 33–64) are user-definable and can be replaced by the user. To modify a drill, create a new drill, or replace a drill, see the RP2.PC section starting on *page 28*.

Drills 33–45 and a few others form a letter or geometric figure when each ball's landing spot is connected by a line. These help teach youngsters not just table tennis skills, but geometry or the alphabet. It also makes it easier to remember where the next shot will be placed on the table.

Drills 46–55 show how skills can be progressively increased in difficulty to keep the student challenged and progressing. Drills 26–30 & several others showcase how randomization is used to keep the student thinking and alert instead of practicing on the robot in a rote fashion.

Many drills place balls in the middle zones and at medium ball speeds so it is relatively easy to stroke them back. This is done on purpose to allow users to gain confidence when executing these drills. As skills increase, or to adapt the drills for players who already have more advanced skills, simply change the head angle, SPEED ADJUST, and/or WAIT ADJUS. For instance, if the trajectory seems too high, lower the head angle and increase the SPEED ADJUST for a drill with lower trajectories, faster ball speeds, and so the balls land deeper on the table.

This works best on drills that have a single ball speed. Drills that have a wide range of ball speeds, for instance one that starts with a short serve having a speed of 2 and then a deep ball with a speed of 17, will be more difficult to adjust without messing up the ball placement. For such drills, it is best to edit the drill in RP2.PC (*see page 28*).

All drills are written for a 2055 which is centered on the end of the table in a level condition. Please check that your robot is level and your table net is set to the legal standard

of 6" high. Some drills include balls that barely clear the table net. If the robot is not level or the net is too high, it can cause these balls to hit the net and not land in the correct spot. Incorrect landing spots for balls can often be easily corrected by slightly nudging the head angle either up or down as appropriate. Also, make sure the Friction Block (79) and Discharge Wheel (78) are clean so ball speeds work correctly.

Owners of Robo-Pong 1055 robots will have to adjust the drills depending upon where they position their robot on the table surface. Most head angles given for the drills will have to be adjusted because the head height of a 1055 on top of the table is higher than a 2055. Use RP2.PC (*page 28*) to edit the existing drills or create new ones specifically tailored to the unique attributes of the 1055.

One way that a 1055 owner could reduce the number of adjustments is to mount the 1055 in a Robo-Caddy and position the Robo-Caddy aligned with the centerline and just beyond the endline of the table (*see Position 5, Figure 12 on page 18*). Adjust the Robo-Caddy so the robot's discharge hole is approximately 39" from the floor. This will closely approximate the head position of a 2055 and the drills should run correctly with few modifications.

The drill diagrams that follow provide the user with a quick understanding of the number of balls in a drill, where each ball is placed, and what strokes and other techniques the drill is designed to strengthen. They are a handy resource when picking a drill and should be kept close to your robot for quick reference.

Here's a legend for the notations used in the diagrams: Bold numbers indicate serves—the ball bounces first on the robot's side. Plain numbers indicate returns—the ball bounces first on the player's side.

Notation	Explanation
1,2,3, etc.	The order in which the balls are thrown (1 is the first ball, 2 is the second ball, etc.)
B	Backhand stroke
F	Forehand stroke
F/B	Either a forehand or backhand (player's choice)
t	Topspin stroke (loop, counter, block, smash, etc.)
b	Backspin stroke (push, chop, drop, etc.)
f	Flip—a topspin attack of a short serve
f/b	Flip or backspin stroke (player's choice)
c	Center—forehand from the center of the table
w	Wide—delivered ball cuts across the sideline
so	Step Out—forehand from backhand side with pivot footwork
!	PAY ATTENTION! Used when there are two or more choices for a particular ball. For instance, a 2Bt! and 2Ft! would mean PAY ATTENTION, for the second ball, it may be either a forehand or backhand and you return it with a topspin stroke.
~	A variable number of balls thrown to one location. For instance, 4~6Bt would mean that starting with ball #4, 1 to 3 balls are thrown to the backhand before a ball is thrown to the next location.

TOPSPIN [ROBOT] ANGLE: 2

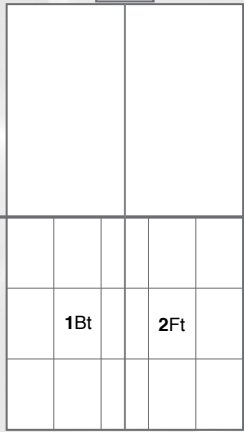

01 B-F Beginner

TOPSPIN [ROBOT] ANGLE: 2

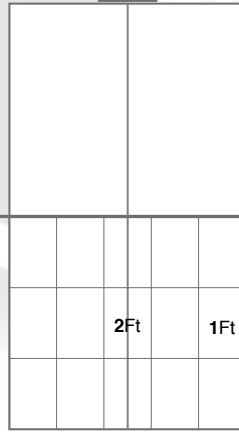

02 F-Fc Beginner

TOPSPIN [ROBOT] ANGLE: 2

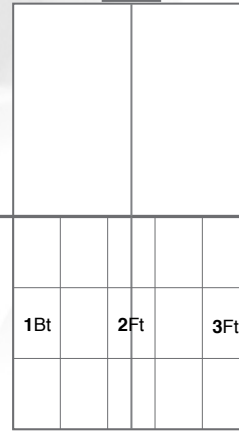

03 B-Fc-F Beginner

TOPSPIN [ROBOT] ANGLE: 2

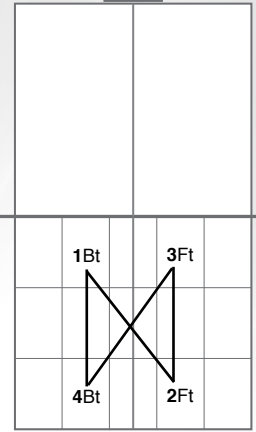

04 Hourglass Beginner

TOPSPIN [ROBOT] ANGLE: 2

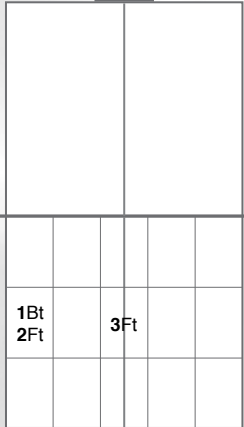

05 Falkenberg Beginner

TOPSPIN [ROBOT] ANGLE: 8

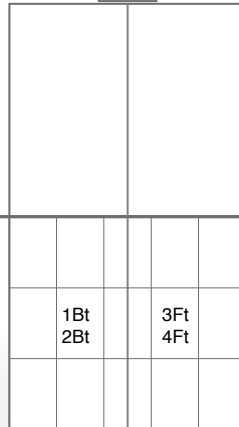

06 2B-2F

TOPSPIN [ROBOT] ANGLE: 8

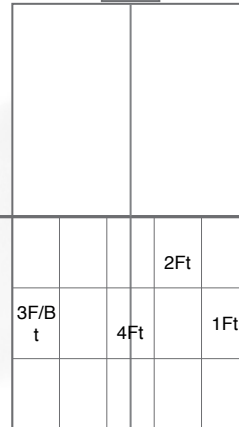

07 F-Fc-B or Fso-Fc

TOPSPIN [ROBOT] ANGLE: 8

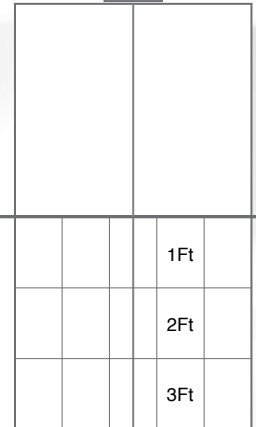

08 F Short-Mid-Long

TOPSPIN [ROBOT] ANGLE: 8

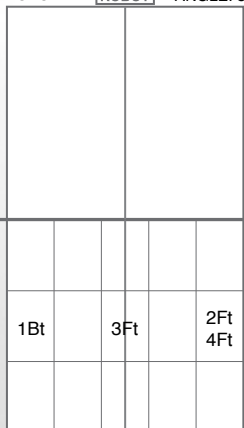

09 B-F-Fc-F

TOPSPIN [ROBOT] ANGLE: 8

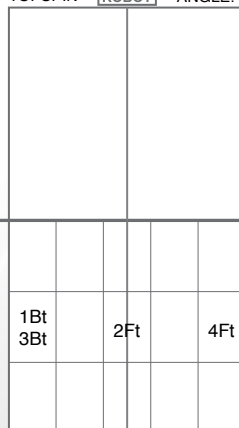

10 B-Fc-B-F

TOPSPIN [ROBOT] ANGLE: 8



11 Forward Slash TS

TOPSPIN [ROBOT] ANGLE: 8

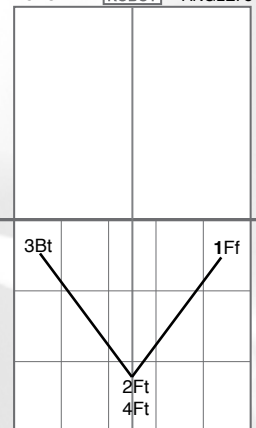

12 V's

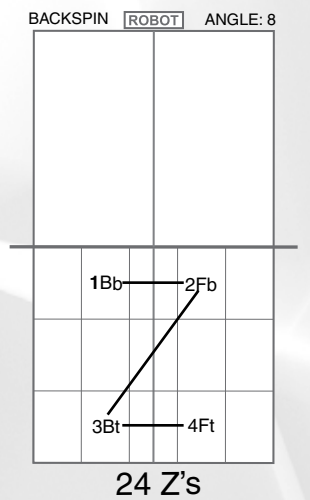
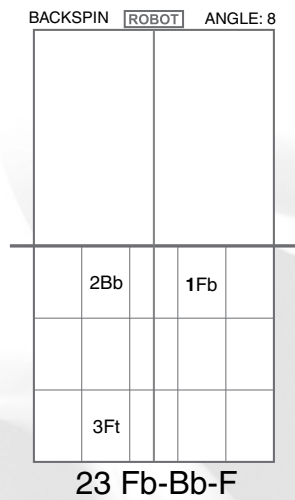
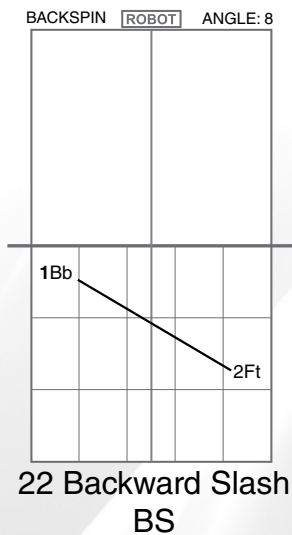
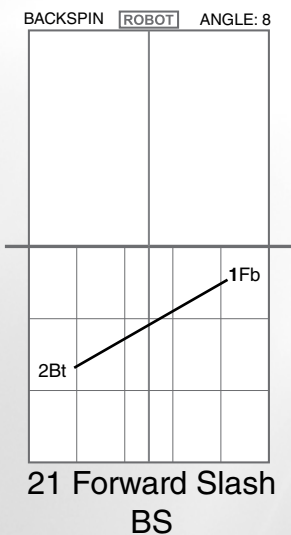
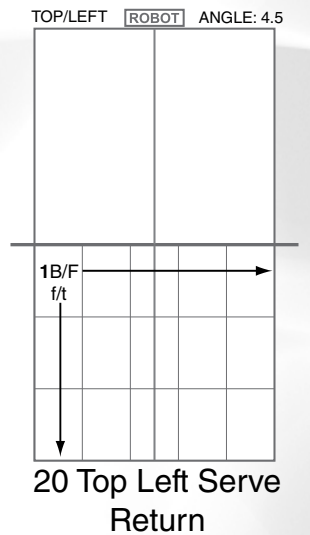
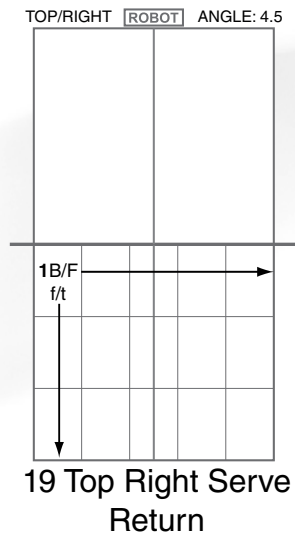
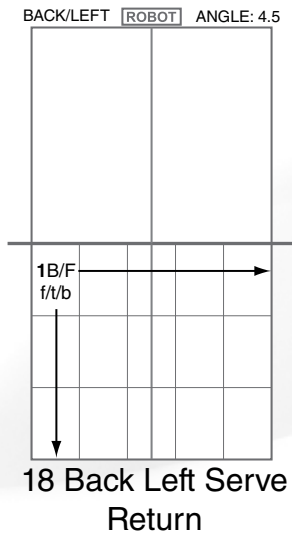
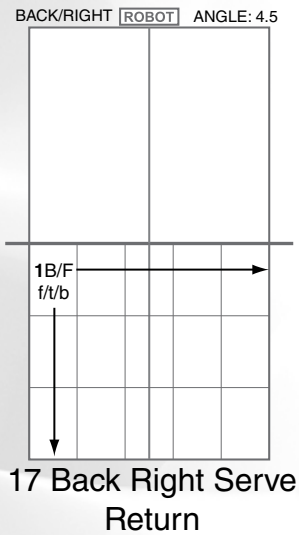
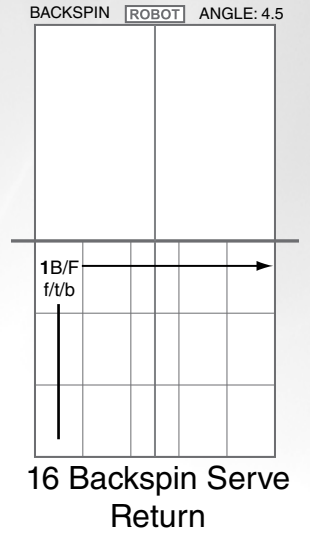
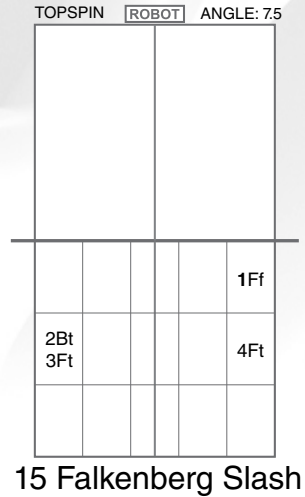
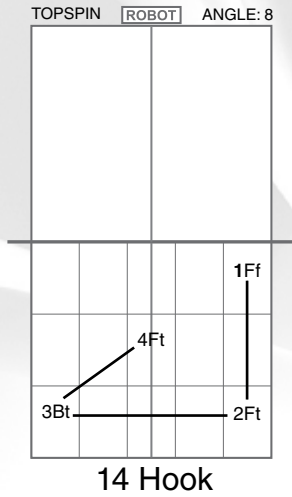
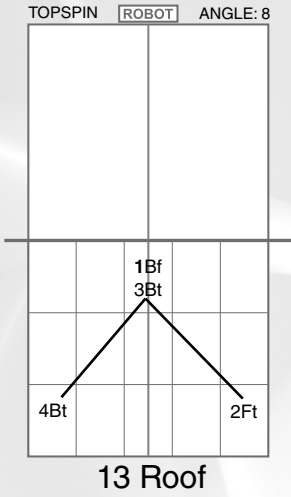

BACKSPIN [ROBOT] ANGLE: 8

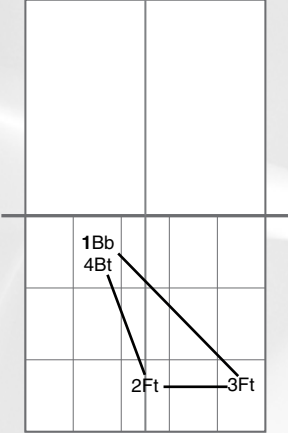

25 Obtuse Triangle
CCW

TOPSPIN [ROBOT] ANGLE: 8

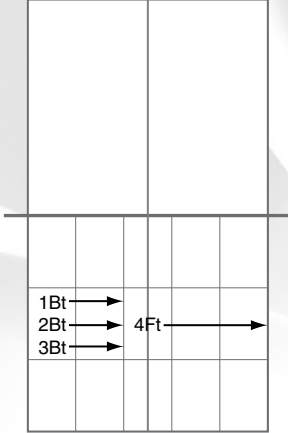

26 3B-1F Random

TOPSPIN [ROBOT] ANGLE: 8

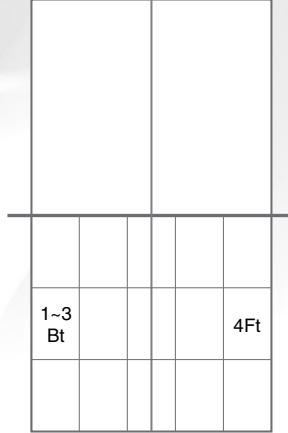

27 1~3B-1F

TOPSPIN [ROBOT] ANGLE: 8

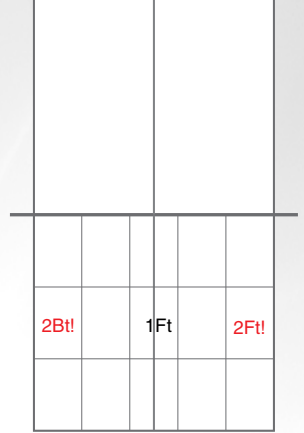

28 Fc-B or F

TOPSPIN [ROBOT] ANGLE: 8

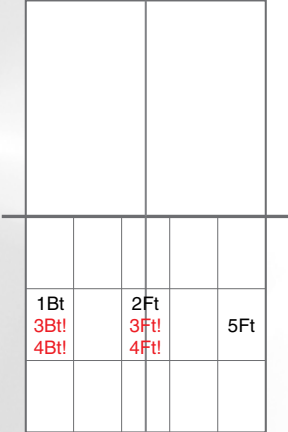

29 B-Fc-B or Fc-B
or Fc-F

TOPSPIN [ROBOT] ANGLE: 8

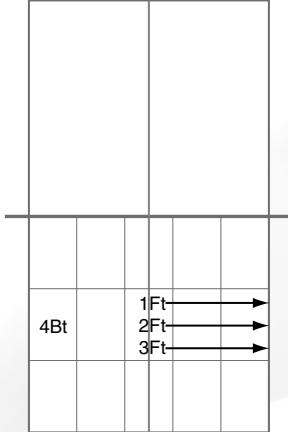

30 3F Random-B

TOPSPIN [ROBOT] ANGLE: 13

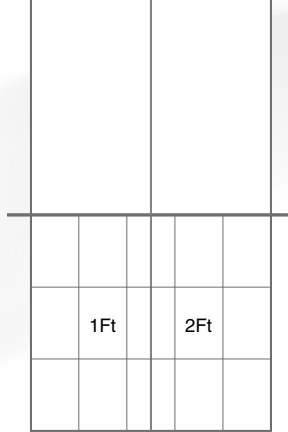

31 F Smash Pattern
vs High Ball

TOPSPIN [ROBOT] ANGLE: 13

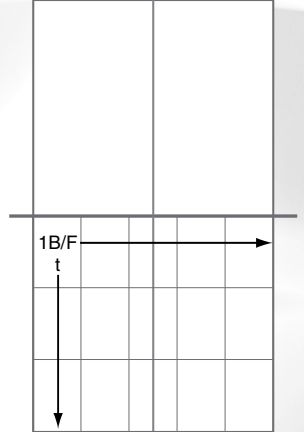

32 F/B Smash
Random vs High
Ball

TOPSPIN [ROBOT] ANGLE: 8

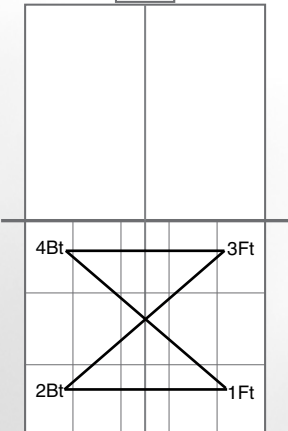

33 Hourglass Vert

TOPSPIN [ROBOT] ANGLE: 8

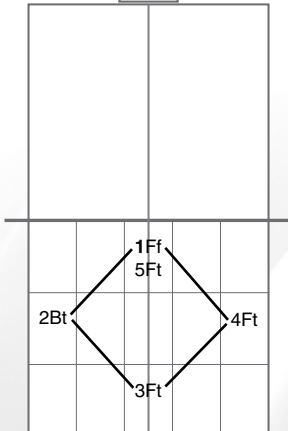

34 Diamond CCW

TOPSPIN [ROBOT] ANGLE: 8

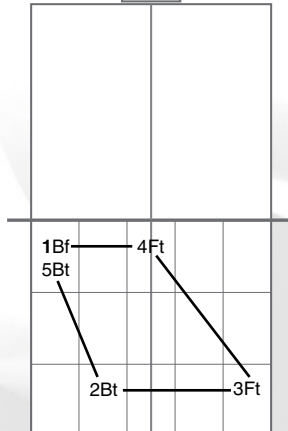

35 Trapezoid CCW

TOPSPIN [ROBOT] ANGLE: 8

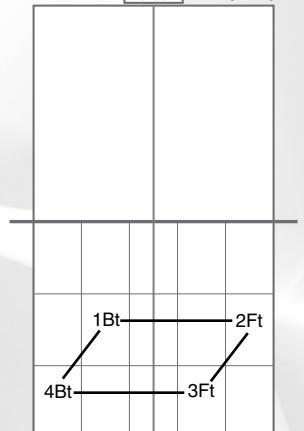

36 Parallelogram
CW

TOPSPIN ROBOT ANGLE: 8

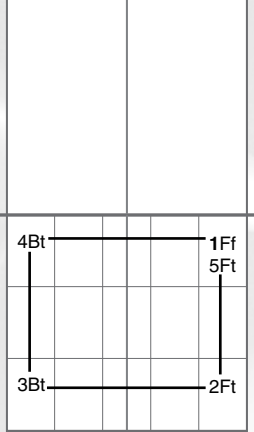

37 Rectangle CW

TOPSPIN ROBOT ANGLE: 8

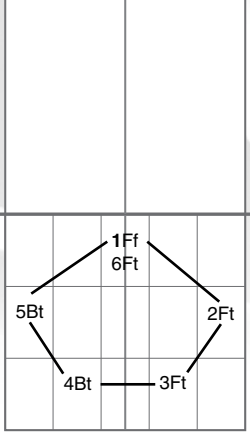

38 Pentagon CW

TOPSPIN ROBOT ANGLE: 8

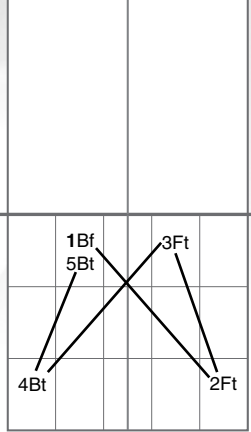

39 Anti Parallelogram

TOPSPIN ROBOT ANGLE: 8

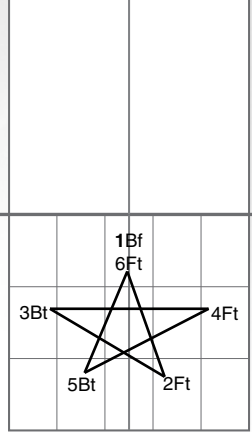

40 Star

TOPSPIN ROBOT ANGLE: 8

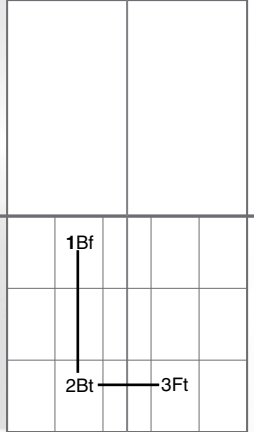

41 L's

TOPSPIN ROBOT ANGLE: 8

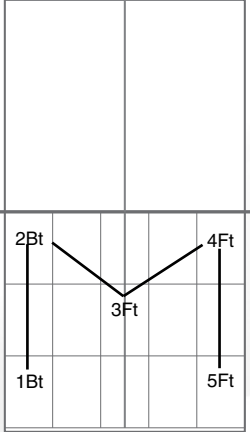

42 M's

TOPSPIN ROBOT ANGLE: 8

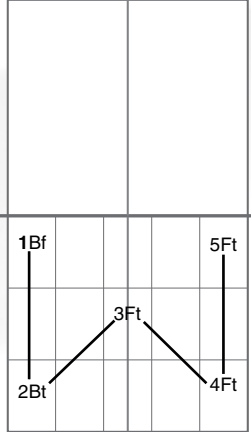

43 W's

TOPSPIN ROBOT ANGLE: 8

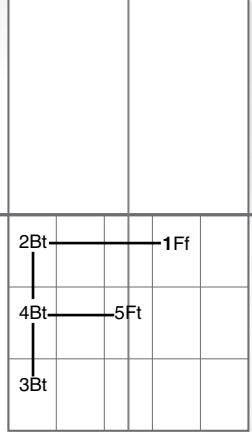

44 F's

TOPSPIN ROBOT ANGLE: 8

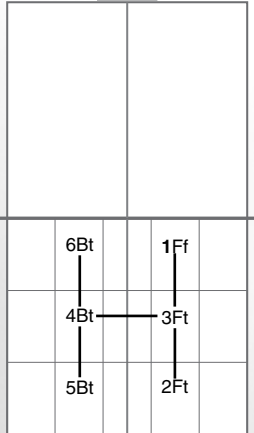

45 H's

TOPSPIN ROBOT ANGLE: 8

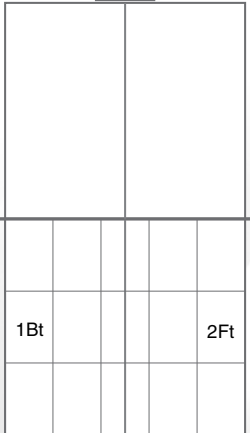

46 B-F

TOPSPIN ROBOT ANGLE: 8

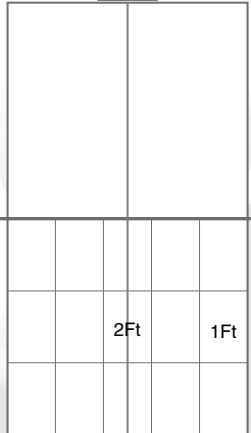

47 F-Fc

TOPSPIN ROBOT ANGLE: 8

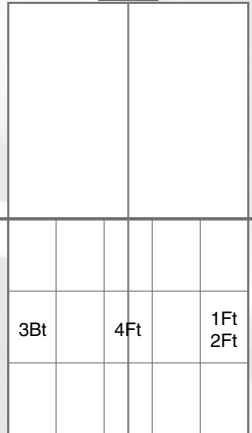

48 2F-B-Fc

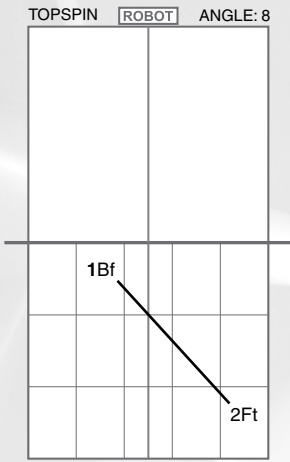

49 Backward Slash
TS

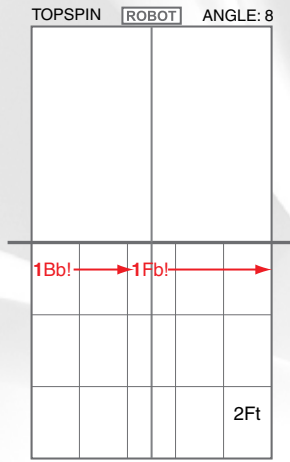

50 Bb or Fb
Random-F

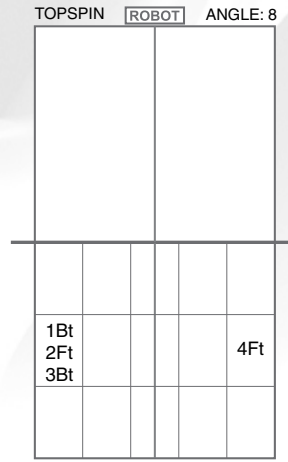

51 B-Fso-B-F

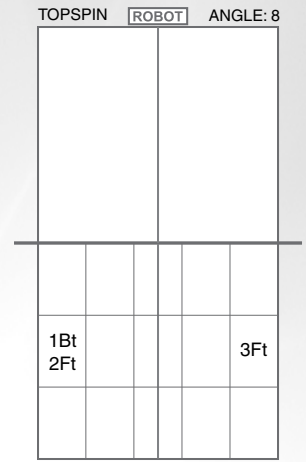

52 Falkenberg

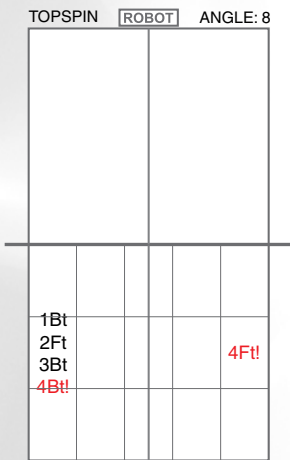

53 B-Fso-B-F or B

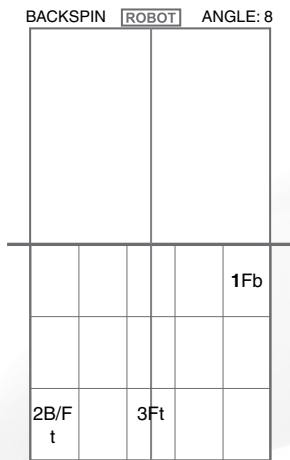

54 Fb-B or Fso-Fc

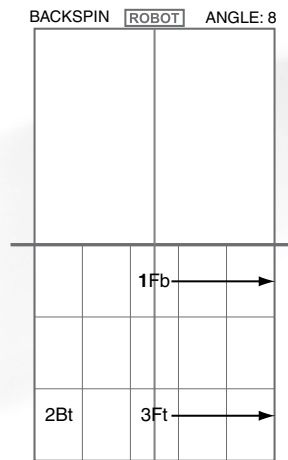

55 Fb Random-B-F
Random

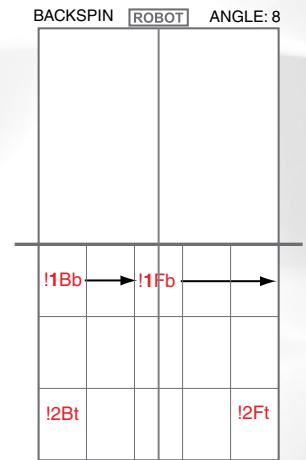

56 Bb or Fb
Random-B or F

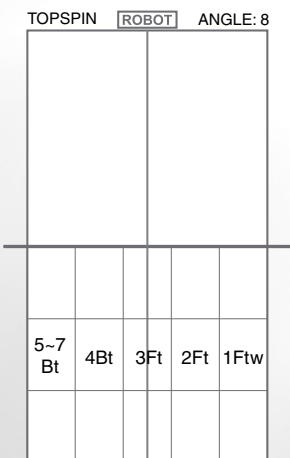

57 Fw-F-Fc-B-
1~3Bw

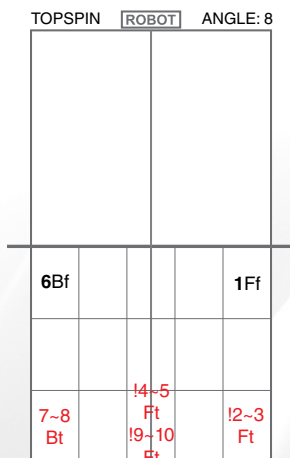

58 Ff-1~2F-1~2Fc-
Bf-1~2B-1~2Fc

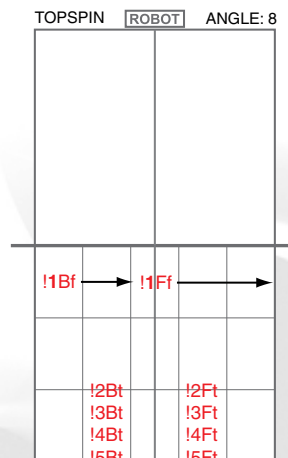

59 B or Ff
Random-B or F-
B or F-B or F-B or F

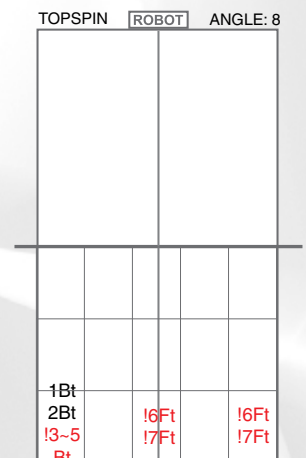

60 2B-1~3B-
Fc or F

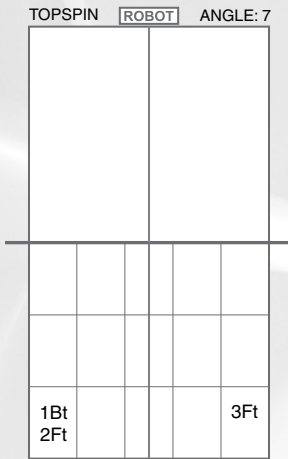

61 Falkenberg Expert

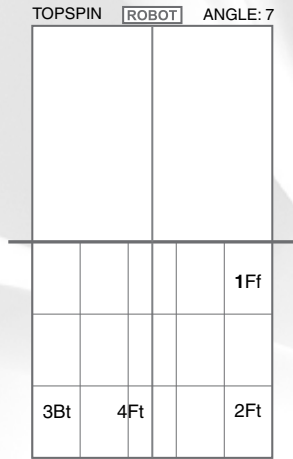

62 Ff-F-B-Fc Expert

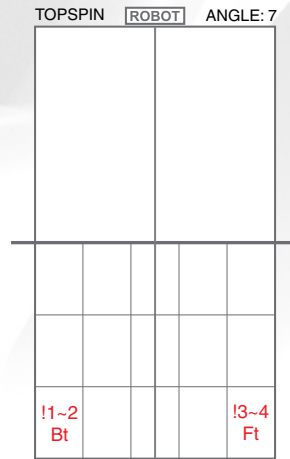

63 2B-2F Expert

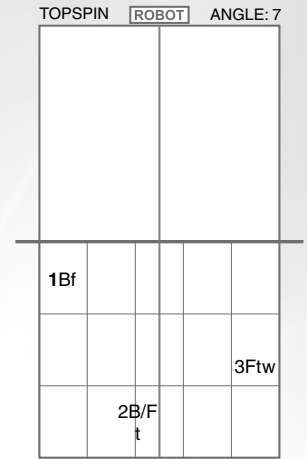

64 Bf-B/Fc-Fw Expert

SPEED CALIBRATION TARGET (ALL MODELS)

Please read explanation of SPEED CALIB on page 13. Copy this page and then cut out this target from that copy. Alternatively, rather than copying the target, you may simply cut a 6" by 6" square from a piece of paper and use that for your target.

Speed Calibration Target For Robo-Pong 2055

Before calibrating the speed, please calibrate the oscillation and clean the Discharge Wheel and Friction Block. Also check that the robot's trays are level. Cut out this target. Place bottom edge of target along endline of table and center marks of target along centerline of table. You may want to use a short strip of tape to hold the target in place:

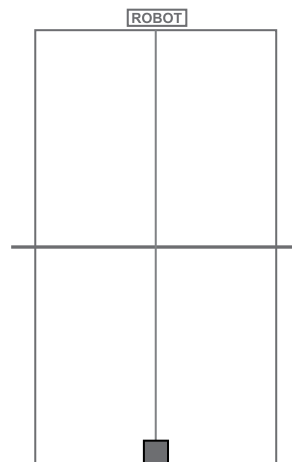

Set Head Angle to 8 and Spin to Topspin. Press the Menu button on the Control Box. Select SETUP and then select SPEED CALIB. Press the yellow TEST button. The robot will throw 5 balls at the target. Note where these balls land in relation to the target. If balls land on the target, no speed calibration is necessary. If balls fall short of target, first try slightly adjusting the head angle. If you can get the balls to hit the target using angles from approximately 7.75 to 8.25, then no calibration is necessary. If adjusting the head angle doesn't work, then adjust the value of SPEED CALIB until balls land on target. If balls are delivered past the target, decrease the value of SPEED CALIB until balls land on target; if they fall short, increase the value.

RP.2.PC PROGRAM (ALL MODELS)

NOTE: RP.2.PC was designed, tested and supported on Windows 10 (64-Bit/32-Bit) only. RP.2.PC was not designed and is not supported on any platform other than Windows 10.

The software application for the 1055/2055 series robots, RP.2.PC offers an intuitive display that speeds the creation of Drills, so you can quickly customize your patterns and quickly gets you back into training. All drills are saved to a database, so there is only one file to recall or save drills to.

Only available via download, go to <http://www.newgy.com/support-downloadable-instructions-manuals.aspx> to get the EXE file for installing RP.2.PC. The 74MB file has the RP.2.PC interface, a USB driver package and a .NET framework package in case your system needs the current version. The steps after the download are outlined below:

RP.2.PC DOWNLOADING AND OPERATION

This is the install icon; double clicking on it will begin the installation.



The first page of the installation; please click "NEXT".

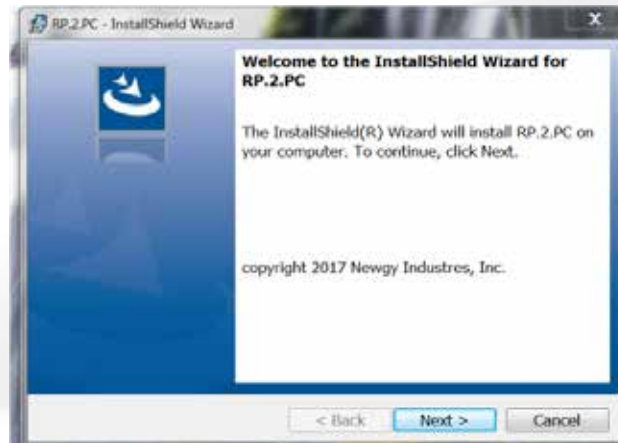

Page 2 is the RP.2.PC file directory click "INSTALL".

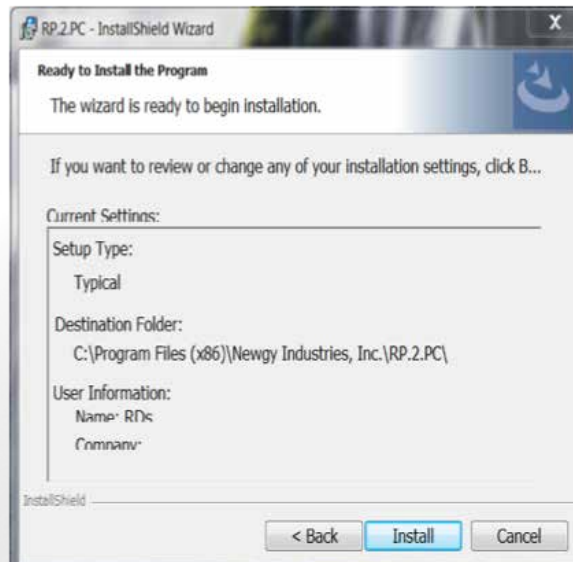

The End User License Agreement for RP.2.PC; click "ACCEPT" then "NEXT".



The last page of the RP.2.PC set up, clicking "Finish" will finish the install or may prompt the USB driver install for systems that require the newest drivers.



Click "EXTRACT" to get the most current driver files.



The Driver Wizard loads the drivers, click "NEXT".

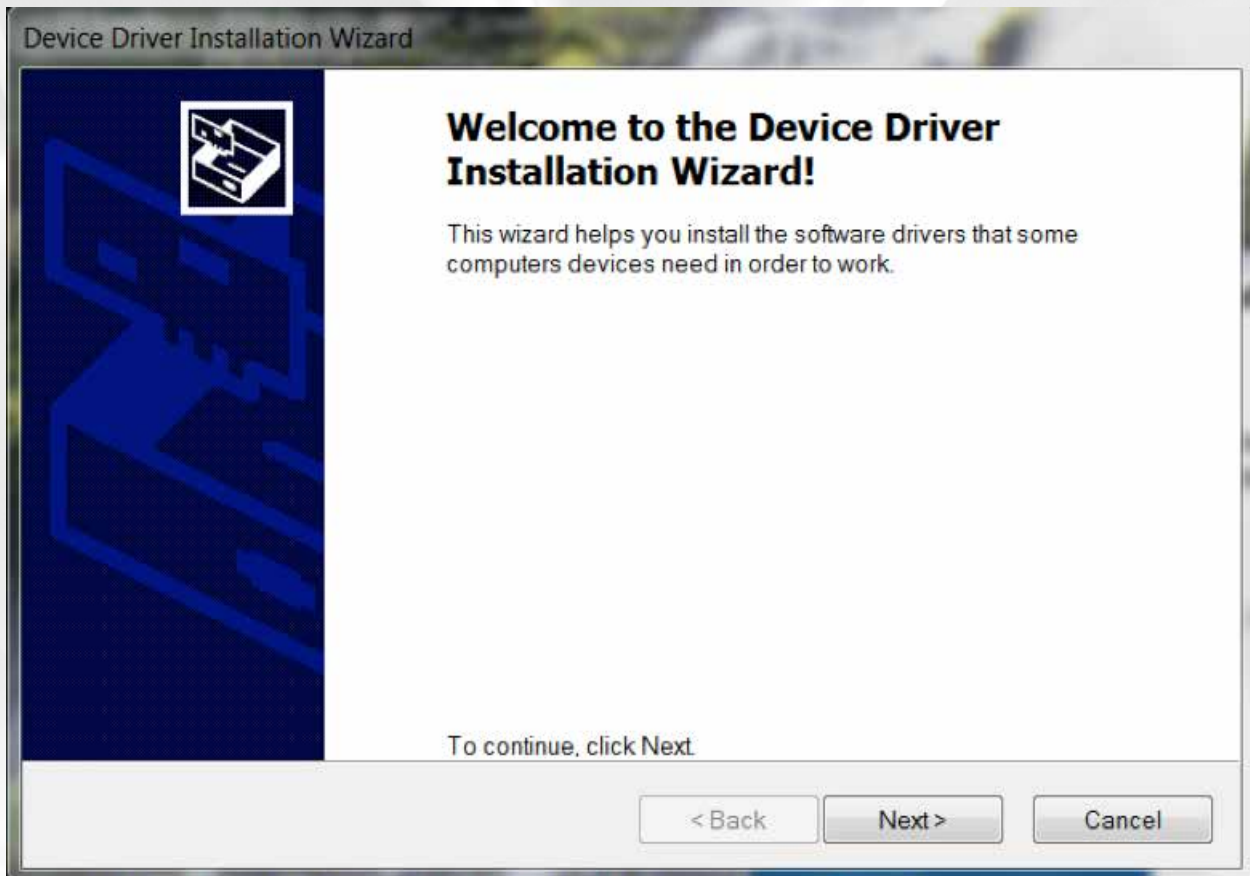

The End Users License Agreement for the drivers, click "ACCEPT" then "NEXT".

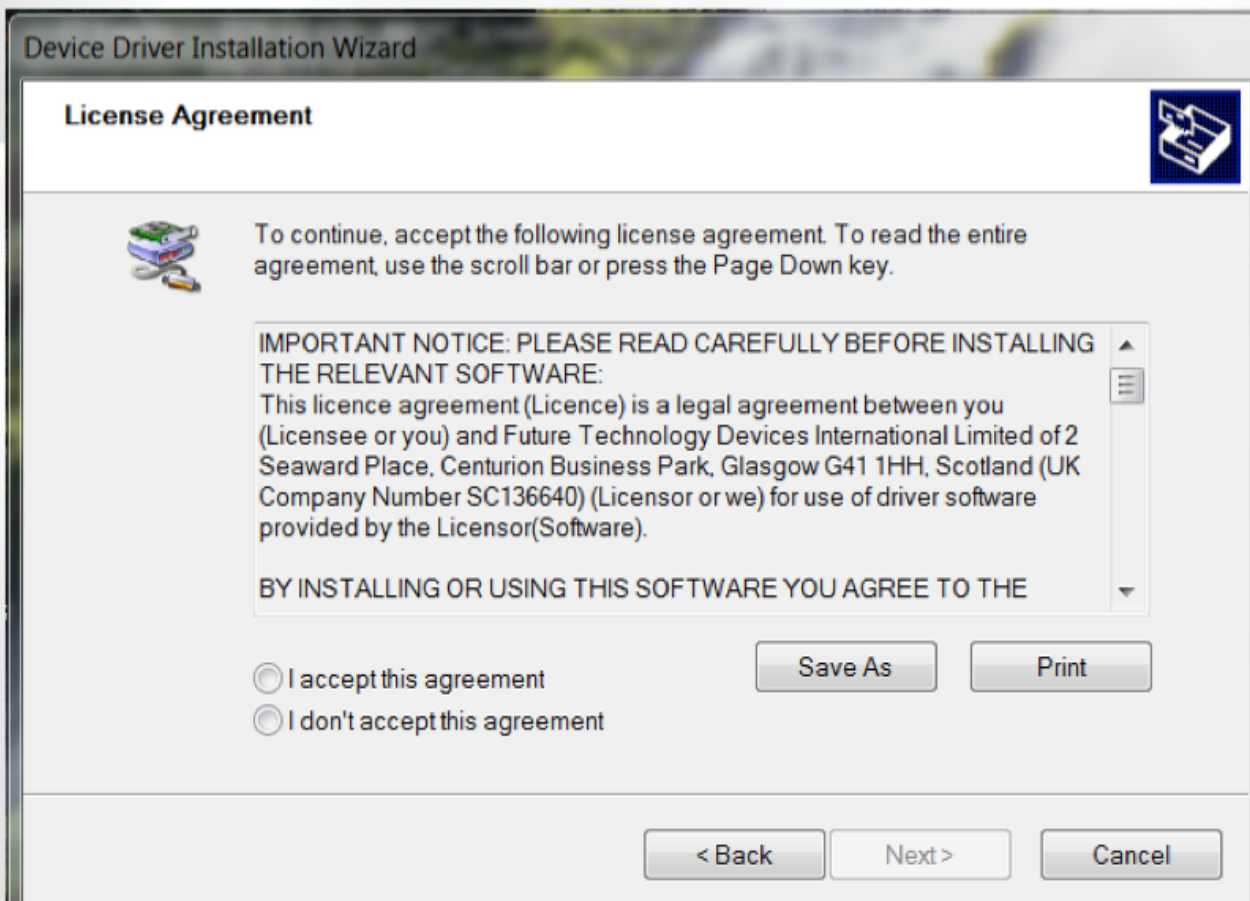

This is the last install page, once you click "FINISH" the screen will close and the RP2.PC application will go to its' first page.

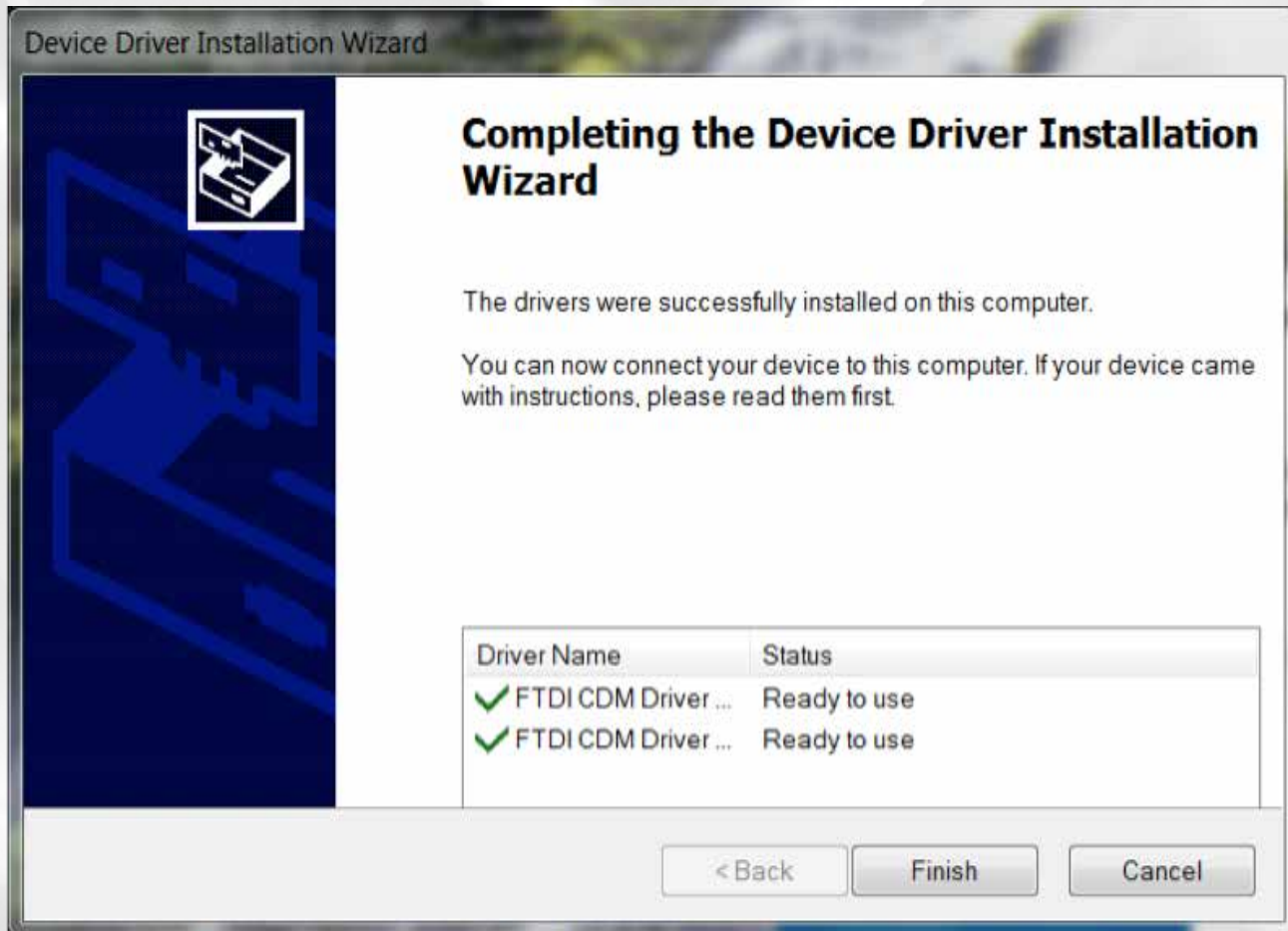

Select your preferred language and the RP2.PC interface will open!



MAIN INTERFACE

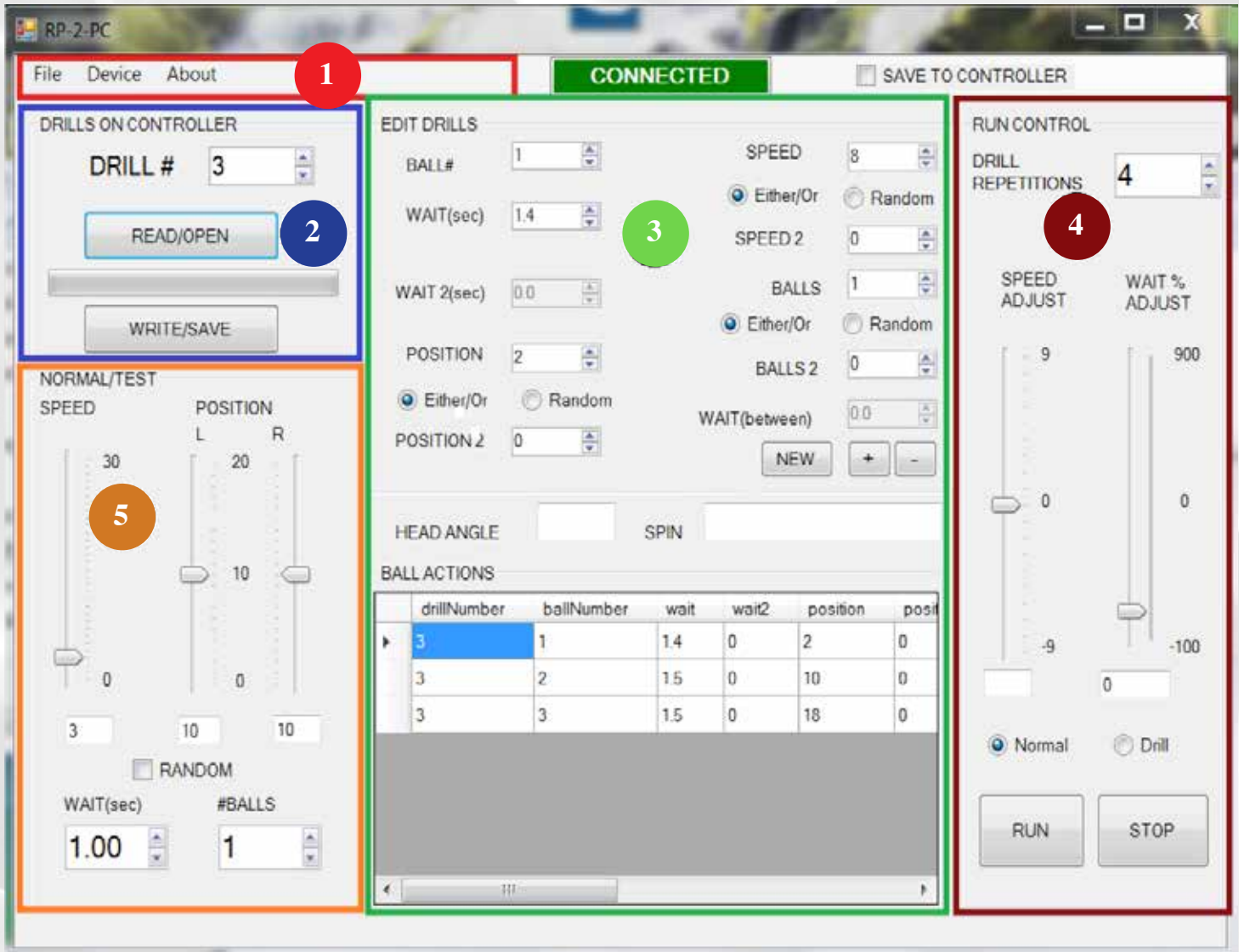

#1 – The **RED** area is a standard drop down area with three items;

- **File** - Export / Import / Exit
- **Device** – Auto Connect/ Disconnect
- **About** – Copyright 2017 Newgy Industries Inc. Version R3.01

#2 – The **BLUE** area is where the ability to select, open/read or write/save a drill. All new drills once saved, will show the number of the new drill in this area.

#3 – The **GREEN** area shows all the values of a ball in a Drill or when you are creating new drills, this is where you decide locations, speed and wait times between the balls. The Ball Actions area will display all the balls in the selected drill from area #1 and will fill as you add new balls to a drill.

#4 – The **DARK RED** area are the RUN CONTROLS for operating a drill selected in area #1 (DRILL ON CONTROLLER) or allows controls for area #5 (NORMAL/TEST) of Run and Stop while using RP2.PC. Once RUN is pressed, it will be locked until STOP is selected. DRILL or NORMAL mode must be selected prior to using that feature.

#5 – The **ORANGE** area is the Controllers for Ball Speed, Oscillation and turning the Random on or off when using the Normal/Test mode while in RP2.PC.

WRITING NEW OR MODIFYING DRILLS

With RP.2.PC you can create new drills or modify drills that are preloaded in the Control Box. The first 32 cannot be modified, they are RUN only. Drills 33-64 MUST contain the same number of balls, though all the values can change. The NEW drills that are created will be saved in the same database as 1-64, so the first NEW drill will be 65 and can have 6 balls. Drills 65+ are never written to the Control Box and run only when the 1055/2055 robot is connected to the PC.

If you want to leave PC Mode / RP.2.PC, select EXIT from the File drop down menu and press the OK/MENU button on the Control Box twice.

To see the values for any Drill; select DRILL# in DRILLS ON CONTROLLER (area #2) then click on the READ/OPEN button. The fields in the EDIT DRILLS section will populate with values for the 1st ball. The BALL ACTIONS area will show each ball and all of their values.

If you have changed a value in Drills 33-64 and want to run the Drill with that value, just set the Drill Repetitions in Area #4, select WRITE/SAVE then select RUN. Using the WRITE/SAVE button, the drill will be saved until the Control Box is powered off. Select SAVE TO CONTROLLER if the change is wanted to replace the original value of a drill.

The first step in creating a new drill would be to click the NEW button in the EDIT DRILLS area (#3). This will put all the values in the fields to the minimums so you can use the up arrows to get to the value desired and NEW DRILL the next number in the database.

Set the HEAD ANGLE and SPIN; these are manual adjustments but are a reminder so the drill will perform as designed/intended.

So for Ball #1 - moving to the right you can set the Ball Speed (0-30) If you select Either/Or under Speed and leave SPEED 2 at 0, the 1st ball will be set just to the speed selected. If Speed 2 is given a value (1-30) then the 1st ball can be the value set at Either SPEED or SPEED 2.

Every Drill starts with a 3 second ramp up for the Ball Speed Motor, so for Ball#1(B1), the next value to create would be the WAIT time before Ball#2 (B2) is thrown. If you want to have set time, leave the WAIT 2 at 0.00. For a varied Wait time add a value in WAIT 2 that is lower or higher than in Wait. Matching the values in WAIT and WAIT 2 has the same effect as having 0.00 as the value in WAIT 2.

ALWAYS remember that if the following Ball Speed is slower than the one prior, the Ball Speed Wheel will need some more time to slow down than to speed up. Also, if the POSITIONS between balls are far apart, it may be better to have more WAIT time to be sure the head is set before sending the next ball.

The POSITION setting (0-20) determines the landing spot and you have two options for setting these positions. With Either/Or chosen and no value or the same value in POSITION 2, the ball will land in the spot that is shown in the POSITION value. Having different values, the landing positions will land in either position. If Random is chosen,

the landing spots will vary between these values chosen.

To set the values for BALL #2, click on the (+) button and the BALL ACTIONS field will populate with the setting for BALL #1 and the fields in EDIT DRILLS will reset to their lowest values.

Having written the actions for each ball in your NEW DRILL, you only need to click on the WRITE/SAVE button in area #2 to save it to the drill database and RP.2.PC will assign it the next available Drill number in the database.

The EXPORT feature allows you to EXPORT (save) the current database with a specific name, so you can create different databases for different training or if you are a coach, different databases for different students. Using the IMPORT feature allows you to IMPORT (open) a different database than the one currently one. This new database will be the default database until you IMPORT a different one. So, no matter where or when, you can create while you are rethinking of the right actions to add to your training program!

NORMAL / TEST

NORMAL/TEST enables simple patterns to be run in RP.2.PC and is a great tool for testing speeds and positions prior to building drills. To enable the controls toggle the NORMAL button in area #4, this will link the START and STOP buttons to the NORMAL/TEST area instead of DRILL. The slide controls in area #5 control SPEED (0-30) and the landing POSITION (Left and Right) of each ball. Random can be toggled on or off and the WAIT (sec.) between balls and total #Balls set. If you leave the number of balls blank, the robot will run until you select STOP in area #4.

IMPORTANT NOTICES (ALL MODELS)

WARNING: These points are vital for proper use and care. Failure to heed these points may cause damage to the robot or cause it to malfunction.

1. When attaching the Connector Cable to the bottom of the Control Box, wrap the cable around the metal Control Box Mounting Bracket as illustrated in Figure 20. This serves as a strain relief for the cable to prevent the cable from being pulled loose. Failure to follow this suggestion may result in erratic behavior from the robot and/or complete disconnection between the Control Box and the robot.
2. Before connecting your robot to power, be sure you have the correct socket adapter to match the electrical sockets where the robot will be used. Also check that the transformer can handle the electric current into which you will plug the robot (see page 37).
3. **Don't use petroleum based lubricants or solvents on the plastic parts of this product.** These chemicals are corrosive to the plastic and will result in structural failure of the plastic parts. Use of these chemicals will void your Warranty and/or Service Policy (see back cover).
4. 2055 and 1055 robots are equipped with a special safety feature to warn you when ball jams occur. **Your Control Box emits a high-pitched squealing noise and shuts off the ball feed when it detects a ball jam!** It also shows a warning on the LCD Screen. Don't worry—your machine is operating the way it was designed to. This shut-off feature prevents damage to the ball feed gears and motor.

Normally the solution is very simple. Turn off your Control Box, then agitate the balls where they feed into the machine. In particular, look for balls that have become stuck around the Ball Feed pickup mechanism. If agitating the balls doesn't fix the problem, then the problem is likely inside the robot.

To inspect inside the robot, remove the balls from the Ball Bucket¹ or the Center Trough² and then remove the robot body by loosening the two wing nuts, disengaging the clips, and pulling the robot body upward. After removing the Clear Front Cover (41, Figure 21 below), look for balls that are cracked, dented, too large, or out-of-round. Discard any bad balls or any foreign objects found in the ball channel. New balls may also cause ball jams. Before placing new balls in your robot, please wash and rub down the balls according to the procedures described in the IMPORTANT NOTICES flyer included with your robot (also available on the Downloads page at Newgy.com).

5. Use high quality ITTF approved 2-star or 3-Star balls, or Newgy Robo-Balls for best performance. Avoid inexpensive non-rated balls, especially those with rough seams. Well-worn balls work best. Use only 40mm or 40+mm balls; do not use 38mm, 44mm, or any sizes other than 40mm or 40+mm. Do not mix 40 and 40+ balls.
6. Store unit indoors only. Do not leave the robot or Control Box outdoors. Avoid leaving unit in a hot car or trunk. Plastic parts can warp, crack, or melt if exposed to extreme temperatures. Do not use robot around sand. Sand will abrade plastic surfaces.
7. When lowering the Ball Return Trays on the 2055, don't let the trays fall down into place. Lower them gently.
8. Do not use sandpaper paddles with your robot. Sand can loosen from the paddle and end up inside the robot where it can abrade plastic surfaces and cause ball jams and other problems.

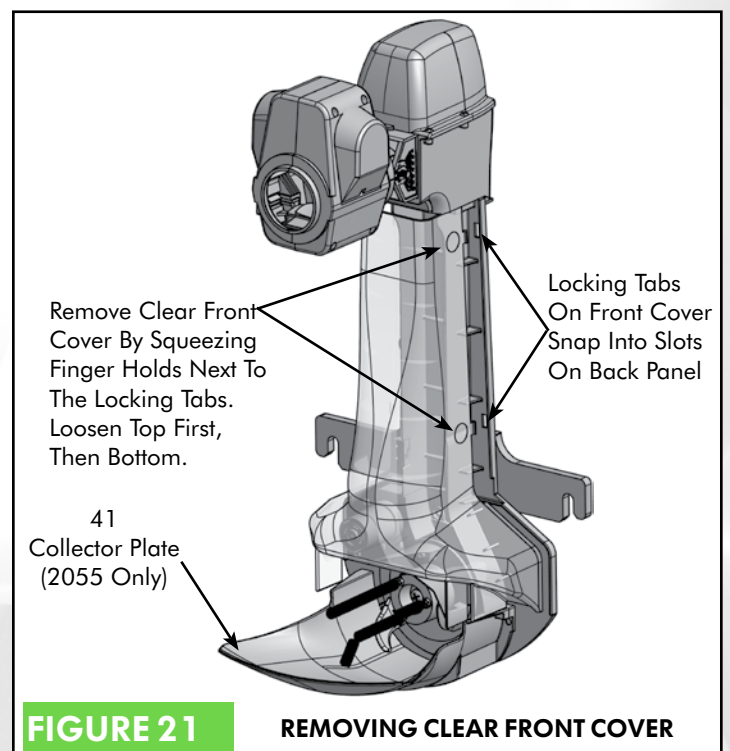

TAKE DOWN, STORAGE, & TRANSPORT (2055 ONLY)

Robo-Pong 2055 is easily taken down in less than 5 minutes. Your robot folds very compactly with all parts inside the robot. This model is lightweight and portable. Follow these steps to be sure all parts fold up correctly.

1

PLACE SIDE NETS IN TRAYS

First, unplug the Connector Cable from the back of the robot. Then detach the Side Nets and place them in the trays.

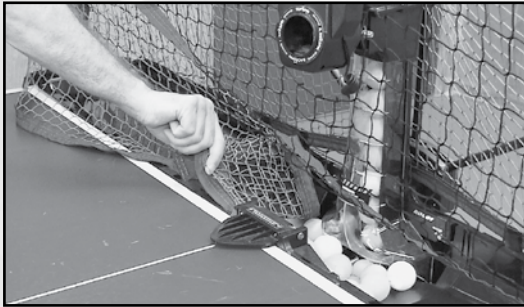

2

PLACE ROBOT ON CORNER OF TABLE

Remove the robot from the table and set it down on the corner of the table to easily access both the front and back of the robot.

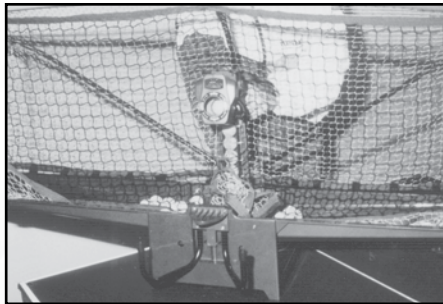

3

REMOVE BALL DAMS

From the front of the robot, raise each tray slightly and remove the Ball Dams (15) from their storage positions. Don't raise too much or the balls will fall out (see Figures 8 & 10 on page 17 for more detail).

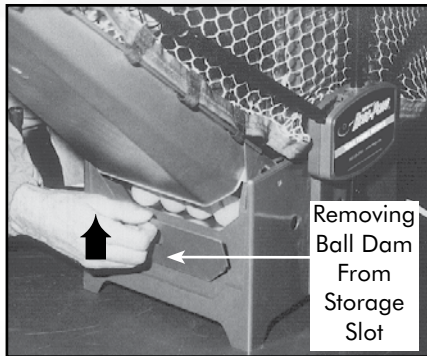

4

INSERT BALL DAMS

Push the balls into the Center Trough (1) and place the Ball Dams (15) in their retaining slots (see Figures 8 & 9 on page 17 for more detail).

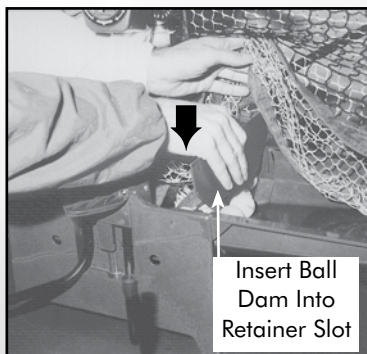

5

PLACE CORDS IN CENTER TROUGH

Unplug all cables from the Control Box and unplug the Transformer from the wall outlet. Coil all cords and place them on top of the balls in the Center Trough. Place the ends of the Side Nets just inside the Ball Dams (15). If you have Pong-Master, you may place its scoreboard and cords on top of the balls as well.

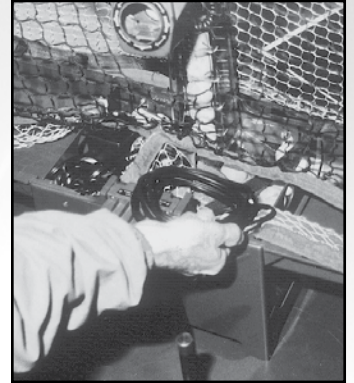

6

PREPARE CB BRACKET FOR STORAGE

Place the Control Box face down on the table. Unscrew it from the mounting arm, flip the bracket around, and then reattach it through its storage hole (the hole closest to the rectangular slot) as shown.



7

PUT CONTROL BOX ON STORAGE POST

Hold the Control Box with the buttons facing you and the bracket facing away. Raise the support leg assembly and slide the Control Box onto its storage post between the Support Legs (8 & 9). Keep assembly raised to prevent Control Box from falling off the post.

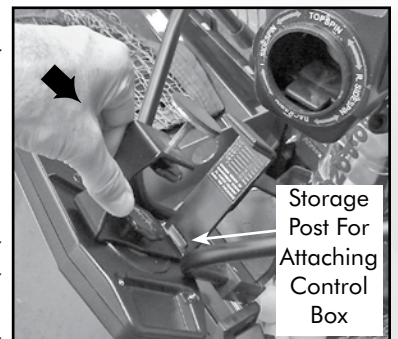

8

FOLD BACK SUPPORT ASSEMBLY

Set the robot head to Topspin and then raise it to its highest angle. Swing the Support Legs inward and fold the whole support leg assembly, with the Control Box attached, into the robot as shown. You may need to hold up the Trap Net while folding the assembly so it does not interfere with the folding process.



9

Fold the Ball Return Trays closed by lifting carefully until they lock into their vertical position.

FOLD TRAYS UP

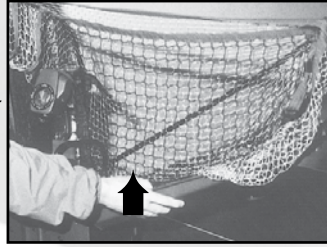

12

Pull the tops of the Ball Return Trays together by buckling the free ends of the Carrying Strap (24) together.

BUCKLE CARRYING STRAP



10

From the back of the robot, detach the left and right Curved Net Support Tubes (19) from their associated Straight Net Support Tubes (18). Place the curved tubes into their storage holes (2nd & 4th holes) on top of the Net Support Plate (21 & 22).

PLACE NET TUBES IN STORAGE HOLES

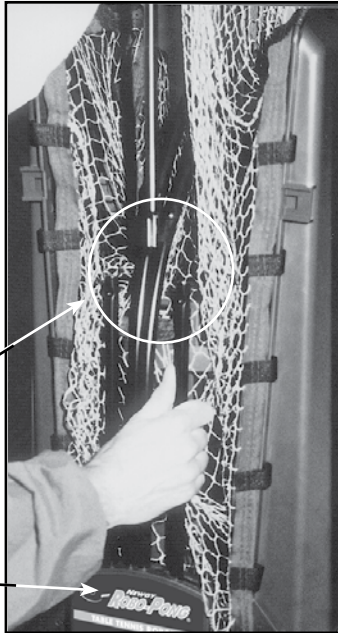

Separating The Upper And Lower Net Support Tubes

Net Support Plate

13

If you purchased the optional Robo-Tote carrying case, your Robo-Pong 2055 will now fit inside the case. The carrying case protects the exterior of the robot during movement or storage and it comes with a back strap for easy transport. The exterior pocket is used to store Pong-Master targets (if you purchased that accessory). When inserting the targets into the pocket, target wires should be furthest down in the pocket to prevent the weight of the wires from bending the edges of the targets.

PLACE ROBOT IN ROBO-TOTE



Pong-Master

11

When the robot is fully folded and with its components in their proper storage positions, all parts fit within the confines of the Center Trough and the Ball Return Trays.

ROBOT PROPERLY FOLDED

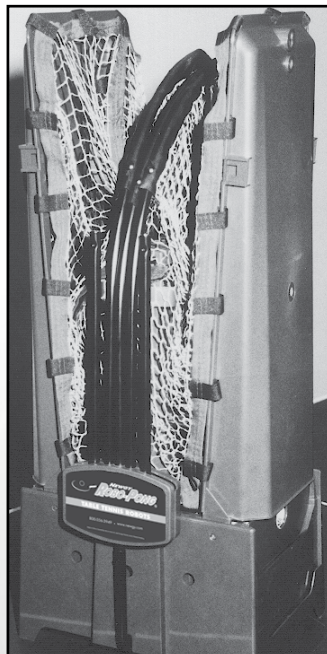
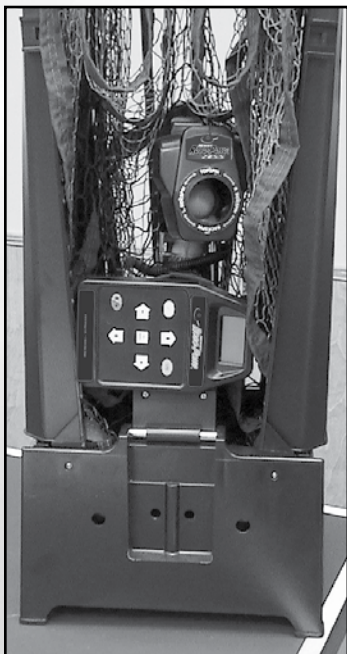

14

With your Robo-Pong 2055 inside its carrying case, it's ready to go anywhere you go. Carry it on your back, store it in a closet, or take it in your car to your friend's house! Your robot will be shielded from dust, dirt, and condensation and all parts will be in one place when you're ready to set it up again.

READY FOR STORAGE OR TRANSPORT



CARE & MAINTENANCE (ALL MODELS)

Robo-Pong robots are easy to maintain. The only maintenance that our robots require is an occasional cleaning. The Ball Discharge Wheel and Friction Block are especially prone to dirt build-up. Periodically inspect these parts and clean with Rubber Drive Cleaner and a cloth. One indicator that these parts are dirty is reduced ball speed or erratic delivery—balls are occasionally ejected sideways, down into the net, or popped up.

It's possible to clean these parts without disassembling the robot head. The following steps show how it is done using Rubber Drive Cleaner and a cloth. This cleaner is terrific for removing dirt from rubber surfaces and restores the natural grip to these parts. If your fingers are too large to clean these parts through the discharge hole, you will need to disassemble the robot head. See Figures C & D on page 44 for disassembly instructions.

To reduce the amount of dirt that enters your machine, keep the table, balls, and playing area clean. Dust, pet hairs, carpet fibers, and other fibrous material can wrap around the drive pin and literally *strangle* the Ball Speed Motor (75) and stop it from functioning. When wiping off the outside of your robot, use a damp cloth. **Do not use any petroleum based solvent, cleaner, or lubricant as these chemicals are corrosive to the plastic. Be careful not to get water on the motors, Control Box, Ball Sensor, or the 5-Pin Connector.**

REMOVE ROBOT BODY

1 First, remove the robot body from the Center Trough² or Ball Bucket¹. Loosen the two Wing Nuts (32) and disengage the black Clip Washers (34). Pull straight up on the robot body to remove it. Then lay it on a flat work surface.



CLEAN FRICTION BLOCK

2 Make sure the word *Topspin* is at the top of the discharge hole. Wet your cloth with a small amount of Rubber Drive Cleaner. Insert the wet cloth into the discharge hole with your index finger and rub it forcefully over the curved rubber surface of the Friction Block (79, Figure D, page 42).



Using a dry, clean section of the cloth, wipe the Friction Block lightly to remove any remaining cleaner and dirt and dry the wheel off.

CLEAN DISCHARGE WHEEL

3 Rotate the head so the word *Backspin* is at the top of the discharge hole. To clean the Discharge Wheel (78), you must insert two fingers into the discharge hole. Wet a clean section of the cloth with the cleaner. Insert one finger into the hole to hold the side of the wheel and keep it from turning. Now, insert the wet cloth with your other finger and forcefully rub the rubber surface of the wheel. After you clean the initial exposed section of the wheel, rotate the wheel a little with your first finger to expose the next section of wheel for cleaning. Keep cleaning a small section of wheel at a time until you've cleaned the entire wheel. Then use a dry section of cloth to lightly dry off the wheel. Lastly reattach the robot body by reversing Step 1.



TRANSFORMER INFORMATION (ALL MODELS)

The transformer that comes with Robo-Pong 1055 and 2055 is a universal switching design. It automatically switches to match the type of electrical current that it is plugged into. Its range is from 100–240 volts AC and 47–63 Hertz. It produces up to 2.0 amps.

It comes with one socket adapter that matches the most commonly found electrical outlet socket in the country from which it was sold. Chart A describes which socket adapter is used for which countries or areas. The list is by no means complete, but lists most major areas that have the type of socket that properly matches with the type of pins shown in the Pins column. Some areas are listed more than once because several different types of sockets are found there.

If the pins on the socket adapter that came with your robot do not match the socket into which you plug the robot, you may purchase one of the other socket adapters from your Newgy parts supplier. To replace the socket adapter, simply press on the small semi-circular tab that is

below the pins and pull the socket adapter out of the transformer's main body. Press the new adapter into the main body until it snaps into place and locks into position.

WARNING: *Never insert the socket adapter into an electrical socket by itself. Be sure it is properly locked into the main transformer body before plugging into electricity.*

Countries/ Areas	Part #	Pins
N. & S. America, Japan, Taiwan, China, India, Iran	2050-223B-US	
Europe, Africa, Korea, Russia, Middle East, S. America	2050-223B-EU	
British Isles, Hong Kong, India, Nigeria, Middle East	2050-223B-UK	
Australia, South Pacific, New Zealand, Argentina	2050-223B-AUS	

CHART A

TRANSFORMER SOCKET ADAPTERS

REPLACING THE MICROPROCESSOR CHIP

Most of the unique features and controls made possible by the digital design of the Control Box are contained in the programming that is burned into the microprocessor. This programming is referred to as the firmware. The PCB (Printed Circuit Board) is designed so that the microprocessor can be changed out easily when the firmware is updated to add features or provide improved performance. Newgy will periodically update the firmware and let owners of our robots know that a new firmware version is available. The firmware will be provided on a new chip that can easily be swapped out with the existing one. This section will detail how to replace the microprocessor.

1

OPEN CONTROL BOX

Begin by removing the 4 Phillips head screws holding the Control Box together. These are accessed by turning the Control Box upside down. Once the 4 screws are removed, you can lift the bottom cover off, exposing the PCB inside.



2

PRY UP CHIP

The chip sits in a raised black chip holder that is close to and parallel with the LCD Screen at one end of the PCB. Remove the chip by prying it out of the chip holder. Special tools are available to do this and should be used if you have them available, but they aren't required. You can also use a tiny flat head screwdriver or an Xacto-type knife. Slide your tool between the chip and the chip holder while being careful not to bend or harm the pins of the chip. Gently pry upwards to lift the chip slightly out of the connector.

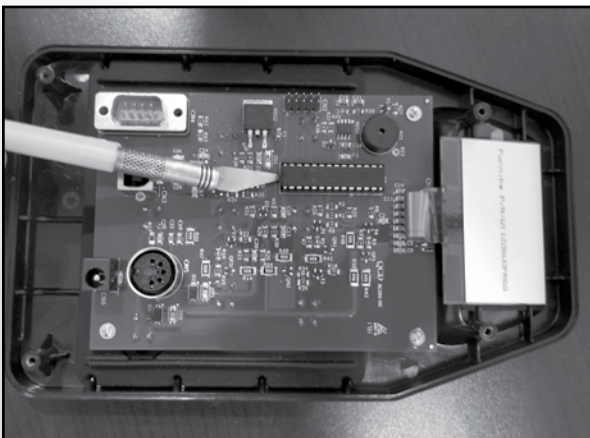

3

REMOVE OLD CHIP

Once you have lifted one side of the chip up slightly, switch to the other end of the chip and do the same thing. Work back and forth between the two ends, prying the chip up a little more each time until the chip lifts away from the chip holder. Set the old chip aside.

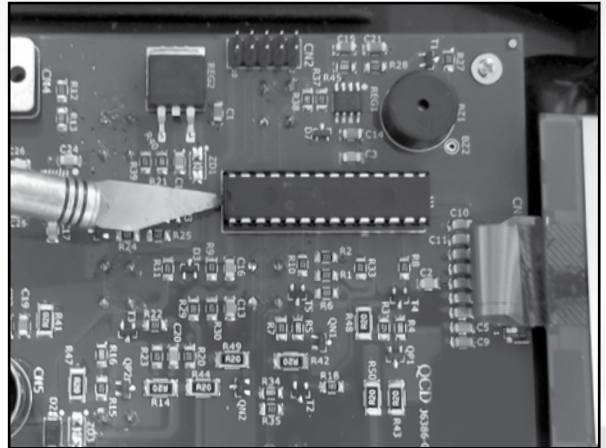

4

INSTALL NEW CHIP

Install the new chip but be careful to properly orient the chip and to not bend the pins. Locate the small semi-circular notch at one end of the new chip. This marks the left end of the chip. Immediately below that notch is a small dot-shaped depression. The dot marks pin 1. Install the chip so that pin 1 goes into the bottom leftmost slot of the chip holder. It may be necessary to gently bend the pins for all the pins to line up properly with all of the slots. Then gently and slowly press the chip into the holder until you are sure that all the pins are going into their associated slots. Then press firmly to seat the pin fully into the holder.

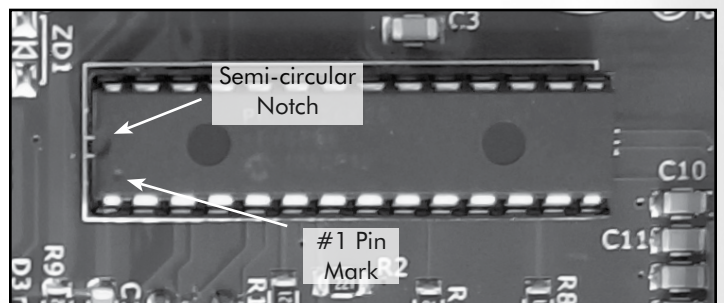

5

REASSEMBLE CONTROL BOX

Reattach the Bottom Control Box Housing with the four screws removed in Step 1. Plug the Control Box into power. The initial boot-up screen will show the new firmware version briefly. Please note that the 64 factory drills are stored on this chip. Any custom drills you have stored in positions 33–64 will not be there anymore. Reinstall them if necessary. Also all Calibration settings are restored to their factory default status, so you will need to recalibrate any of these settings that you have changed. We recommend recording all your calibration settings on the back cover of this manual.

TROUBLESHOOTING GUIDE

- NOTES:**
1. The first step to resolve any unusual behavior from the robot is to unplug from power and then re-plug into power. If that doesn't resolve the problem, restore settings to factory default (see page 14) before trying other solutions.
 2. If you do not have the proper soldering equipment and experience, please send in your robot and/or Control Box for service when soldering is indicated. Control Box parts are small and easily damaged. Improper soldering may void your warranty and service policy.
 3. If the suggestions below do not help, please check our website for an updated copy of this manual. It can be downloaded from <http://www.newgy.com/support-downloadable-instructions-manuals.aspx>.

NO POWER PROBLEMS

1. PROBLEM

No robot functions work and Control Box does not display anything.

SOLUTIONS

- A. Make sure Transformer is plugged securely into a power outlet. Verify the outlet is working.
- B. Check that the plug on the end of the Transformer cord is securely plugged into the Control Box power jack.
- C. Check that the Socket Adapter is securely connected to the Transformer Main Body. See page 37.
- D. If A, B, & C check out, the Transformer may be damaged. If possible, test with voltmeter. Nominal output is 15vdc \pm 0.75 volt.
- E. If recently exposed to shock, the Control Box may have an internal broken connection. Replace or send in for repair to an authorized service center.
- F. The main chip may be loose or damaged. Press the chip firmly into its socket. Replace if damaged.
- G. See Problem 17.

2. PROBLEM

No robot functions work or work sporadically and the Control Box screen displays normally or is garbled.

SOLUTIONS

- A. Reset the Control Box by removing the Transformer plug, waiting several seconds, and plugging it back in.
- B. Make sure the Connector Cable is securely plugged in at both ends. To help prevent the Connector Cable from loosening, wrap cable around the Control Box Mounting Bracket. See Figure 20, page 34.
- C. Control Box is damaged. See Solution 11C.
- D. Connector Cable is damaged. See Solution 11B.

BALL FEED/FREQUENCY PROBLEMS

3. PROBLEM

Robot will not pick up balls.

SOLUTIONS

- A. If the LCD Screen indicates a ball jam, see Problem 16.
- B. Ball Feed Transfer Gears (47) and/or Main Gear (44) are damaged or assembled incorrectly. See Figure I, page 45 for correct assembly. Replace gears with stripped teeth, that won't spin freely, or other damage.
- C. Pickup Fingers (46) and/or Ball Feed Springs (48, 50, & 52) are loose, broken or missing. See Figure I, page 43 for correct assembly. If loose, tighten; if broken or missing, replace.
- D. The robot is not fully or correctly seated in the Center Trough² (1)/Ball Bucket¹ (36). Loosen the two Wing Nuts (32) securing the robot body, reposition the robot body so that it is fully seated. Retighten the wing nuts. See Figure 14, page 19.
- E. Ball Feed Motor (49) runs backward. See Problem 10.

F. Ball Feed Main Gear (44) is frozen to shaft of Ball Feed Mounting Plate (42). Replace gear and plate. See Figure I, page 45.

G. Ball Feed Motor (49) isn't running. See Problem 11.

H. If ball feed stops after 3-6 balls thrown, Ball Sensor is damaged. Replace. See Figure H, page 43.

4. PROBLEM

Robot frequently shoots two balls at once.

SOLUTIONS

- A. The Ball Feed Sensor (40) is damaged, not being activated or its calibration value is incorrect and needs adjustment. Check that wiring to sensor is sound. Verify that the microchip is fully seated in its chip holder on the PCB. Refer to SENSOR CALIB on page 12 for explanation of sensor function, calibration and further troubleshooting.
- B. Robot Head is tilted beyond its normal range. If head angle is less than 1, change to more than 1.
- C. Check Valve Spring is worn out, bent or loose. If loose, tighten. If bent, straighten. If worn out, replace. See Figure H, page 45.
- D. Connector Cable is damaged. See Solution 11B.
- E. The Ball Discharge Spring (58) is broken or worn out. Replace with a new spring. See Figure D, page 42.
- F. Pickup Fingers (46) are loose, broken, or missing. See 3C.
- G. Using dirty balls or balls of the wrong size. Clean balls in warm soapy water, then rinse in clear water and dry. Check balls with a Ball Dam² to be sure they are of the correct size and roundness. See page 17.
- H. Check SENSOR CALIB value. If 55, reset to 10 (page 12).

BALL SPEED/DISCHARGE PROBLEMS

5. PROBLEM

Ball speed seems to be slower than when new.

SOLUTIONS

- A. If in Drill Mode, check SPEED ADJUST. See page 10.
- B. The Ball Discharge Wheel (78) and/or Friction Block (79) are dirty or worn. Clean these parts periodically according to the instructions on page 37. If worn, calibrate ball speed to compensate. See SPEED CALIB on page 13. If calibration does not resolve the problem, replace both parts at the same time. See Figures C & D, page 42.
- C. Ball Speed Motor (75) has hair or fibers entwined around its drive pin. Clean, if necessary. See Fig. C, page 42.
- D. Ball Speed Motor (75) requires lubrication and cleaning. See Solution 11E.
- E. Balls are too small or dirty. See Solution 4G.
- F. The brass shaft of the Ball Speed Motor (75) is loose. This shaft is permanently pressed onto the motor's drive pin. It cannot be reattached. Replace the motor. Test by holding the rubber wheel with a finger and without letting go, turn power on and adjust Ball Speed to maximum. If you hear the motor spinning

while holding the wheel stationary, then the brass shaft is loose. If the motor does not spin, then the shaft is securely fastened.

6. PROBLEM

Robot picks up balls, but balls just fall out of discharge opening instead of shooting out.

SOLUTIONS

- A. Ball Speed set to zero. Set to 1 or higher.
- B. Ball Speed Motor (75) isn't running. See Problem 11.
- C. Ball Discharge Wheel (78) is broken or very worn. Replace. See Figure C, page 42.
- D. Balls are too small. See Solution 7F.

7. PROBLEM

Robot shoots erratically. Some balls delivered high, others low or off to the side or ball speed changes without changing BALL SPEED value.

SOLUTIONS

- A. Verify that no randomization of ball speed is being used. See SPEED RANDOM (p. 9) or if in Drill Mode, check drill for speed randomization with RP2.PC (p. 32).
- B. See Solution 5B.
- C. Balls are dirty or dusty. Clean balls in warm soapy water. Then rinse in clear water and dry.
- D. See Solutions 11F and 12E.
- E. Control Box component failure. Replace or have serviced by authorized service center.
- F. Check for correct ball size and roundness (see Figure 11, page 17). Only 40mm or 40+mm balls can be used.
- G. Ball Speed Motor mounting screws (91) are loose. Tighten. See Figure C, page 42.
- H. Slots in Robot Head Housings for Friction Block tabs are worn. Replace housings. See Figure D, page 42.

OSCILLATOR PROBLEMS

8. PROBLEM

Balls are not delivered to the correct position.

SOLUTIONS

- A. Calibrate the oscillation. See OSC CALIB, page 12. If oscillator won't calibrate, check for correct assembly of the Oscillator Drive Pin (83) to the Servo (85). See Figures A & B, page 42. Also watch video at <http://www.newgy.com/troubles shooting.html>
- B. Check status of OSC RANDOM. See page 9.
- C. Set the HAND option to match your dominant hand. See HAND, page 12.
- D. Servo may be worn or damaged. Replace with new servo and recalibrate. See Figure B, page 42 and OSC CALIB on page 12.
- E. Be sure robot is centered along end of table. If using a 2055, center rib of Front Support Plate (5) should align with centerline of table. If using a 1055, robot should be positioned at junction of centerline and endline. See Robot Position 1, Figure 12, page 18.
- F. Connector Cable is loose. See Solution 2B.
- G. Be sure Clear Front Cover (53) is properly attached. See Solution 16C.

9. PROBLEM

Head does not move between shots.

SOLUTIONS

- A. Check that L POSITION and R POSITION are set to different values to enable oscillation movement.

- B. Something is obstructing the head's movement, possibly the Ball Speed Coiled Power Wire (76). Turn off robot, clear any obstruction and try again.
- C. Servo (85) may be worn or damaged. See Solution 8D.
- D. Check connection between the Servo wire and the Oscillator Power Wire (86) at top of Upper Guide (54). If loose, connect securely.
- E. Be sure oscillator parts are properly assembled and not broken. See Figures A & B, pg. 42 for proper assembly.
- F. Servo isn't running. See Solutions 11A, B, C, and D.
- G. Check OSC CALIB value. If 55, reset to 25 and calibrate the oscillation (pg. 12).

GENERAL MOTOR PROBLEMS

10. PROBLEM

Ball Speed or Ball Feed Motor runs backward (clockwise).

SOLUTIONS

- A. Connector Cable is loose. Perform Solutions 2A & 2B.
- B. Broken or intermittent ground circuit in the Connector Cable. Replace with a known good cable. See 11B.
- C. Check that wires are correctly soldered to proper terminal of the corresponding motor. See Figures D & I, pages 42 & 43.

11. PROBLEM

One or two motors don't run, but the others run normally.

SOLUTIONS

- A. Connector Cable is loose. See Solution 2B.
- B. One or more of the wires inside the Connector Cable are broken. Test with a known good cable if possible or use a voltmeter to check for continuity, including from the round metal sleeve at one end of the cable to the round metal sleeve at the other end (this is the cable's ground circuit). Replace if damaged.
- C. Control Box is damaged. Test with second Control Box if possible. Or run Self Diagnostics (page 14) and report test codes to a service technician. Replace or send in for repair to authorized service center.
- D. Robot wiring contains a short or open circuit. Carefully check robot wiring for conductive debris and exposed or broken wires. In particular, check that the power wire for the non-functioning motor is securely soldered to the 5 Pin Connector PCB (89) and that the 5 Pin Connector (88) is securely soldered to its PCB. Also check that the wires are securely soldered to the motor. Replace damaged parts or re-solder loose connections.
- E. If the machine has not been used for a while, the motor may be *frozen*. Set the motor's corresponding Control Box value at its fastest speed and press the Start button. Then rotate the Discharge Wheel (78) or Pickup Wheel (45) by hand. The motor should start running normally. Reduce motor speed to minimum. Then lubricate with electrical contact cleaner/lubricant.
- F. The motor may be worn or damaged. The motor can be tested by touching the motor terminals with the posts of a 9-volt battery. Before testing, disconnect any gears that are connected in sequence to the motor. If the motor does not run from battery power, it must be replaced. Alternatively, run Self Diagnostics (see page 14) and report test codes to service technician. Replace.

12. PROBLEM

A motor runs, but does not change speed when the corresponding setting is changed on the Control Box.

SOLUTIONS

- A. Reset the Control Box. See Solution 2A.
- B. Control Box component failure. See Solution 11C.
- C. Connector Cable is loose. See Solution 2B.
- D. If Servo moves only at full speed, causing the robot to jerk and jump, see Solution 11C.
- E. If Ball Speed Motor runs only at full speed or pulsates, check for a short in the Servo by disconnecting the Servo's wire. If problem goes away, replace the Servo. If the problem remains, replace the Control Box PCB.

DRILL MODE

13. PROBLEM

Drills deliver balls too long or too short.

SOLUTIONS

- A. Set SPEED ADJUST to 0.
- B. Set head angle to match the drill's recommended setting. Then nudge up or down from given setting to adjust depth of landing spot on table.
- C. Verify the robot's Ball Speed is correctly calibrated. See SPEED CALIB on page 13.
- D. Clean Discharge Wheel and Friction Block. See pg. 37.
- E. Verify that table and robot are level. If short balls are hitting the net, check net height—it should be 6" high.

14. PROBLEM

Drills deliver backhand balls to the forehand side of the table, or vice versa.

SOLUTION

- A. HAND is set incorrectly. See page 12.

15. PROBLEM

There is no Drill Preview for a drill.

SOLUTION

- A. Not all drills make use of the Drill Preview option. No Preview is normally provided for a drill that includes randomization of Ball Speed or Position because the landing spots cannot be accurately shown. The drill will still run normally. Consult DRILL DIAGRAMS section (pages 21–27) for more detail and for printed diagrams of ball landing spots. If DRILL # is 33–64, it may be a user-installed drill without documentation or Preview. Check landing spots against drill diagrams. If different, you can restore drills to match those in DRILL DIAGRAMS by using the *Set Drills To Factory* command in RP2.PC (see page 29).

BALL JAMS

16. PROBLEM

Balls jam inside the machine. Ball jams are normally indicated by a beeping noise from the Control Box and the message—BALL JAM ALARM CHECK BALL CHANNEL—appears on the LCD Screen.

SOLUTIONS

- A. Make sure Connector Cable is securely connected at both ends. The Jam Alarm can be falsely activated if the Control Box doesn't sense a connection to the robot. Securely connect the Connector Cable and the Jam Alarm will go away. Also see Figure 20, page 34.
- B. Using very dirty balls. Dirty balls may create excess friction as the balls are pushed through the ball channel. Clean balls in warm soapy water, rinse in clear water, and then dry. Dirt build-up on the Friction Block (79) and/or Ball Discharge Wheel (78) can narrow the

opening between these parts, denting the balls and/or causing ball jams. Periodically inspect these parts, and if necessary, follow cleaning instructions on page 37.

- C. Clear Front Cover (53) is not fully attached. Verify that all four clips of the cover are fully through their slots on the Back Panel. See Figure 21, page 34.
- D. New, oversized, irregular, dented or damaged balls. Inspect balls for proper size by sliding a ball by hand up and down the ball channel after removing the Clear Front Cover. Remove any abnormal balls or any balls that do not slide easily through this ball channel. Wash & rubdown new balls as described in the IMPORTANT NOTICES available on the *Downloads* page on Newgy.com.
- E. Foreign objects or loose parts in the ball channel. Remove Clear Front Cover (Fig. 21, pg. 34) and remove anything that is obstructing ball flow. Verify that Ball Feed Fingers (46) are attached securely. Also inspect inside the head.
- F. Worn or damaged Ball Discharge Spring (58). Open the robot head and inspect the *back* surface of the spring for wear. Replace if any flat shiny surface is found or the spring is otherwise damaged. Should be completely round with no flat spots. See Figure D, page 42.
- G. Ball Speed Motor runs backward. See Problem 10.

LCD SCREEN

17. PROBLEM

LCD Screen does not display properly—blank screen, garbled text, or screen is stuck.

SOLUTIONS

- A. See Solution 2A.
- B. Activating a Special Function (see page 13) will cause the screen to go blank and then turn black. This is normal behavior. Hit the Power button twice to leave Special Function mode without activating a special function.
- C. If text is very light and/or background very dark, CONTRAST may be set incorrectly. This can occur unexpectedly and without user involvement. Adjust CONTRAST (see page 11) to a more visible setting (10–20) or perform a Factory Default Restoration (see pg. 14).
- D. If screen displays normally when the Connector Cable is disconnected, but goes blank or becomes garbled when the cable is connected, there is likely a short in the electrical system, probably the servo or sensor. See *Technical Service Bulletin #5 (TSB5)* on the Newgy.com website.
- E. If screen is displaying in a foreign language that you cannot read, select desired language by following instructions for *Language Selection*, page 13–14.
- F. Connect the robot to a PC and run the *Set Screen To Factory* command in the *Device* menu of RP2.PC. This updates the firmware to fix rare instances of blank or garbled screens.
- G. If LCD displays a low voltage like 10.5V during startup, the Control Box PCB is faulty and needs to be replaced.
- H. If LCD slowly fades to black, replace Control Box PCB. May also be accompanied by message, "Wrong voltage, check transformer" before fading.
- I. Servo is damaged. See Solution 8D. This type of servo damage can in turn cause Control Box PCB damage (see Solution 12D).

¹Robo-Pong 1055 only, ²Robo-Pong 2055 only

EXPLODED VIEWS, DISASSEMBLY, AND REPAIR

- NOTES:**
1. Refer to the following drawings when disassembling or assembling the robot. The key numbers used to identify the parts correspond to the key numbers on the Parts List on page 45.
 2. There are no adjustments to any robot parts. If there is a faulty or worn part that causes the robot to malfunction, that part must be replaced. Your robot is designed to be easily serviced and repaired.
 3. Do not use petroleum based lubricant, solvents, or other chemicals on plastic parts. These chemicals are corrosive and will cause the plastic to weaken or disintegrate.

FIGURE A

SERVO COVER, PIVOT GUIDE & UPPER GUIDE ALIGNMENT

When assembling these parts together be sure the Drive Pin of Part 83 fits into the Slot of Part 82. Also be sure that the upper Pivot Pin of Part 82 fits into the corresponding hole of Part 84 and the lower Pivot Pin of Part 82 fits into the corresponding hole of Part 54.

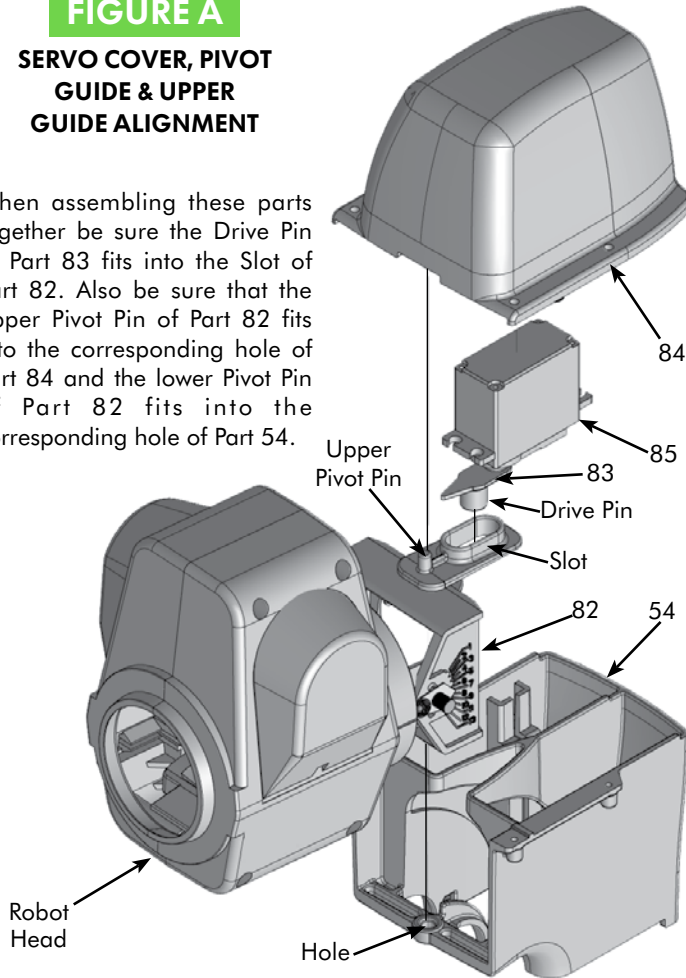

FIGURE B

OSC. ALIGNMENT

Install Servo (85) into Servo Cover (84) and hook up to power. Before attaching Drive Pin (83) onto Servo, connect robot to Control Box and set OSC CALIB to 25, then press TEST. Now attach Drive Pin to Servo and press TEST again so the pin's pointer points to the centerline mark of the cover as closely as possible (it may not be possible to align it exactly). Then screw the pin onto the servo. Be sure pin's gears and servo's gears mesh properly. After reassembly, perform OSC CALIB.

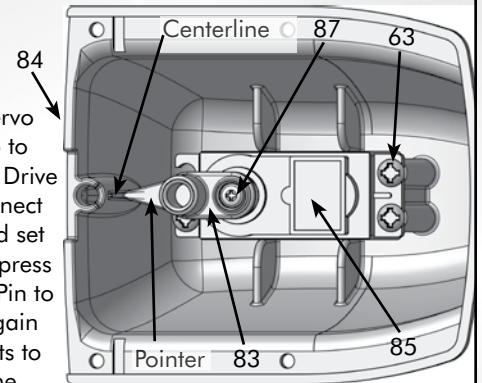

FIGURE C

BALL SPEED MOTOR & WHEEL TO HOUSING

WARNING: The screw (81) is left-hand threaded! Loosen by turning clockwise; tighten by turning counter-clockwise.

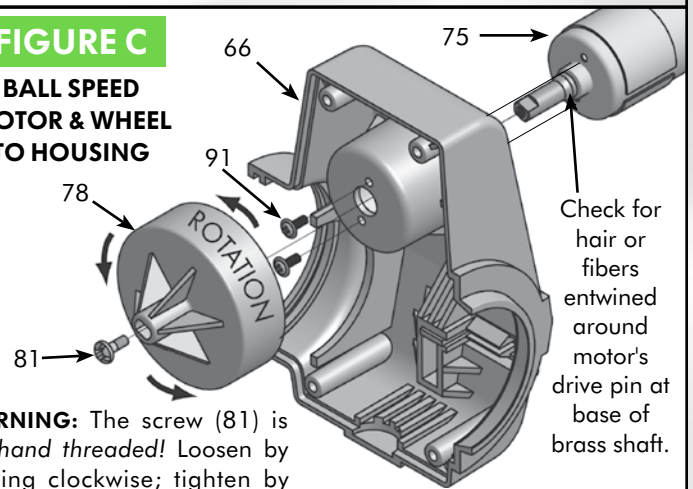

FIGURE D

ROBOT HEAD ASSEMBLY

1. When disassembling the robot head, do not let the Detent Pin (67) fall out of the Left Housing (65) since it's small and easy to lose! Work atop a towel to prevent loss of parts.
2. Split the Head and Spin labels in half with a razor blade to allow the two head halves to separate.
3. A small amount of Superglue® (cyanoacrylate) holds the Ball Discharge Spring (58) onto the Discharge Tube (56). Scrape off old glue before replacing the spring.
4. Keep Friction Block (79) and Discharge Wheel (78, Figure C) clean for correct ball speeds. See page 37 for cleaning procedure.

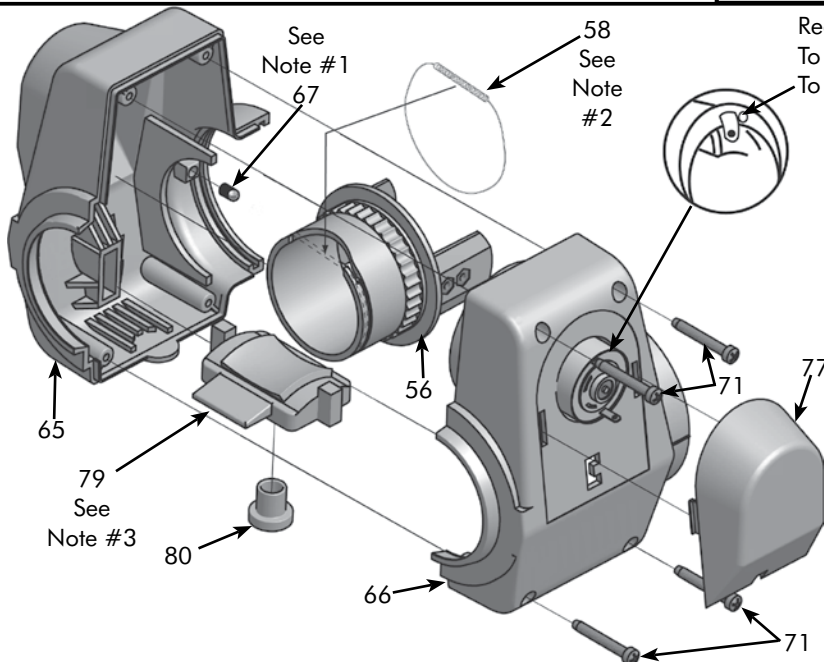

FIGURE E

ROBOT HEAD TO PIVOT GUIDE

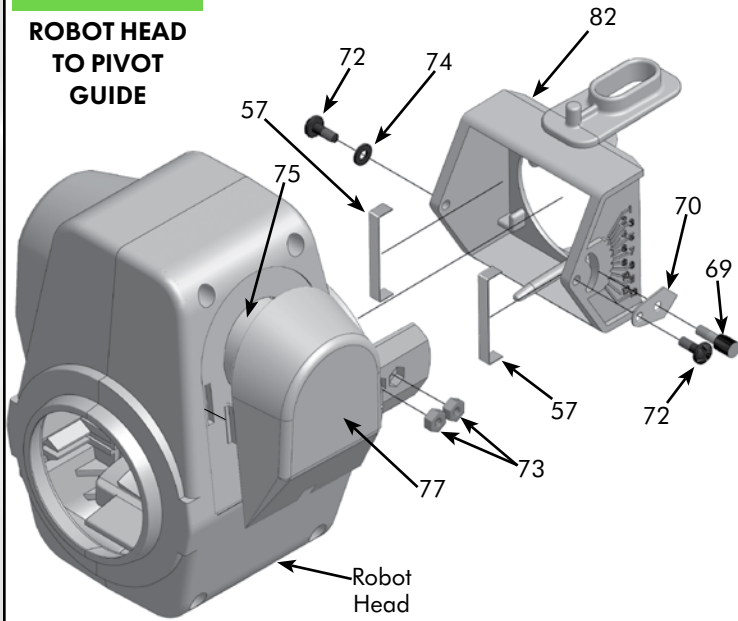

FIGURE F

5-PIN CONNECTOR & PCB

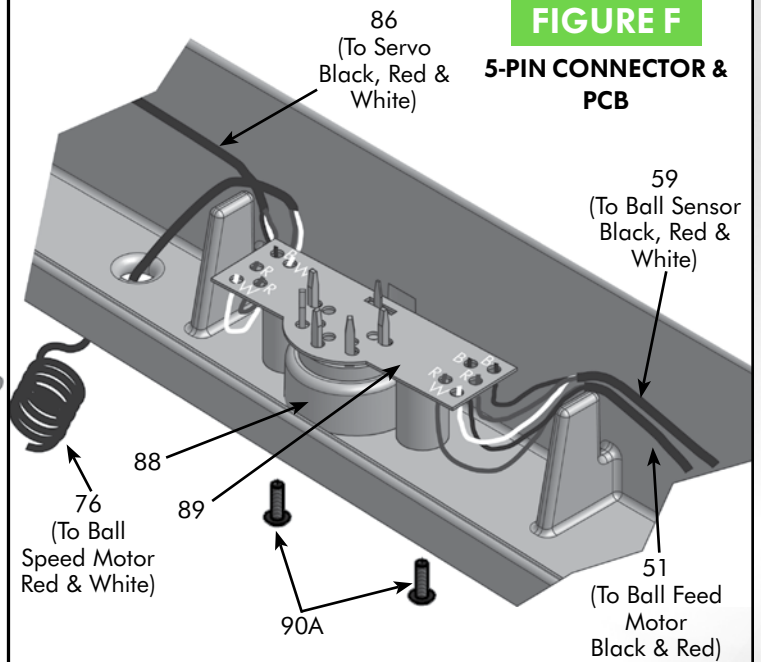

FIGURE G

BALL FEED UPPER GUIDE TO BACK PANEL

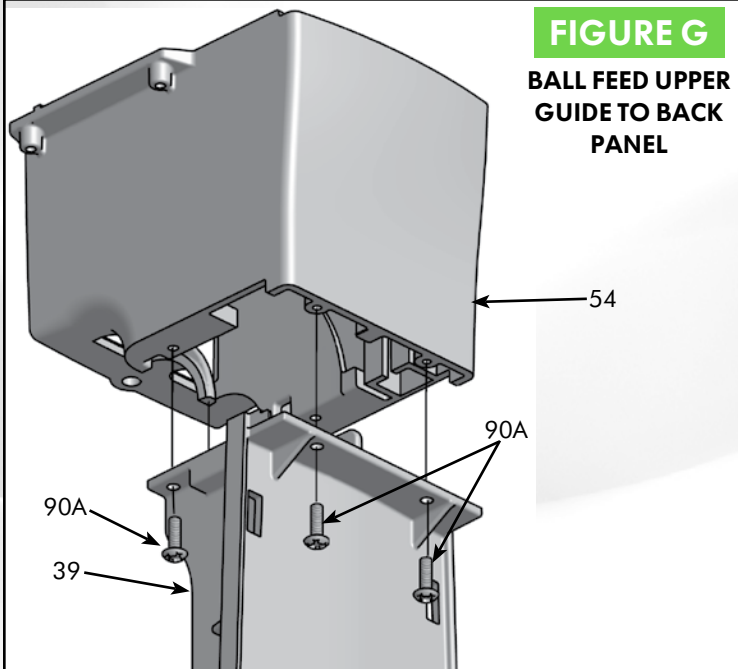

FIGURE H

BALL SENSOR TO BACK PANEL

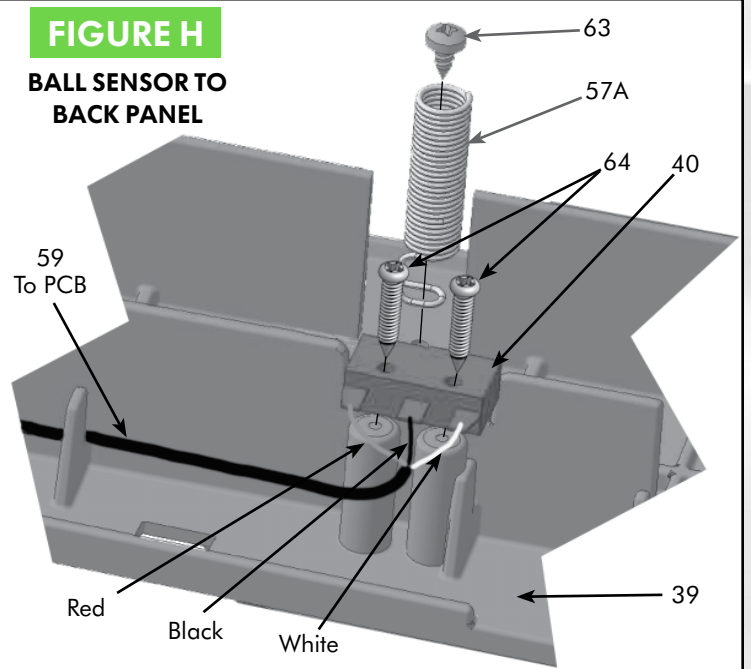
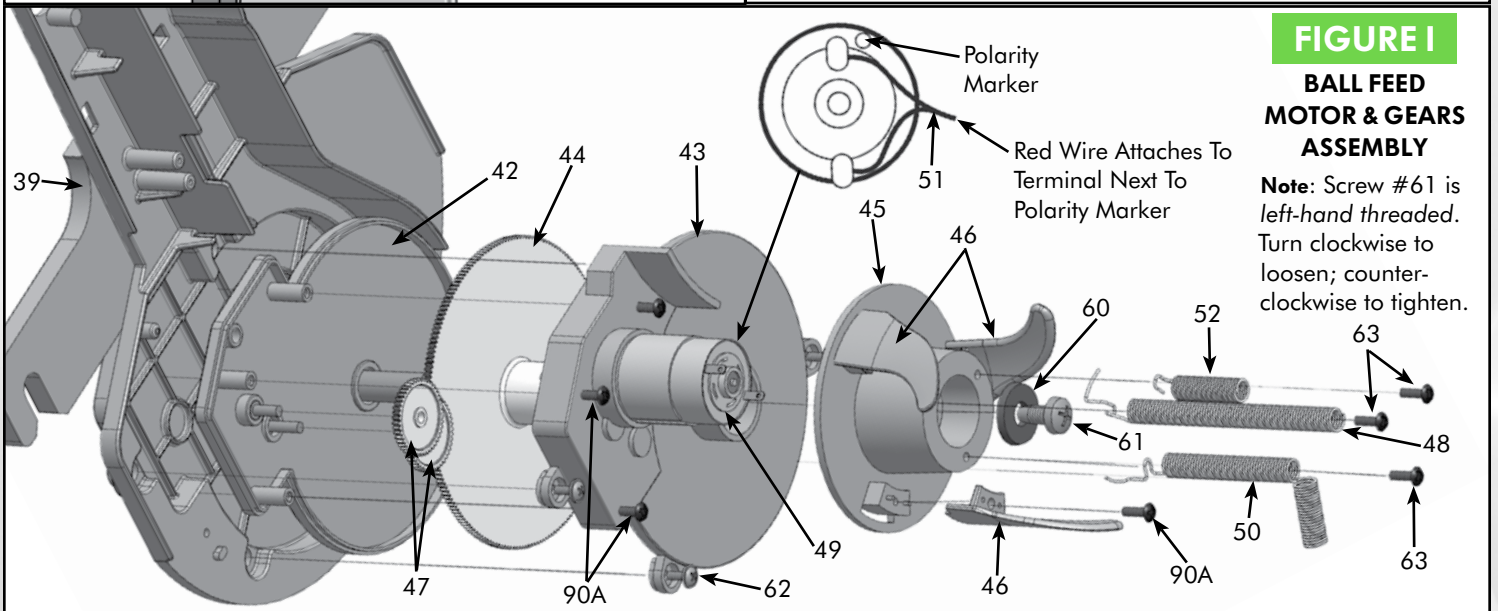

FIGURE I

BALL FEED MOTOR & GEARS ASSEMBLY

Note: Screw #61 is left-hand threaded. Turn clockwise to loosen; counter-clockwise to tighten.



PARTS LIST FOR NET ASSEMBLY (2055 ONLY)

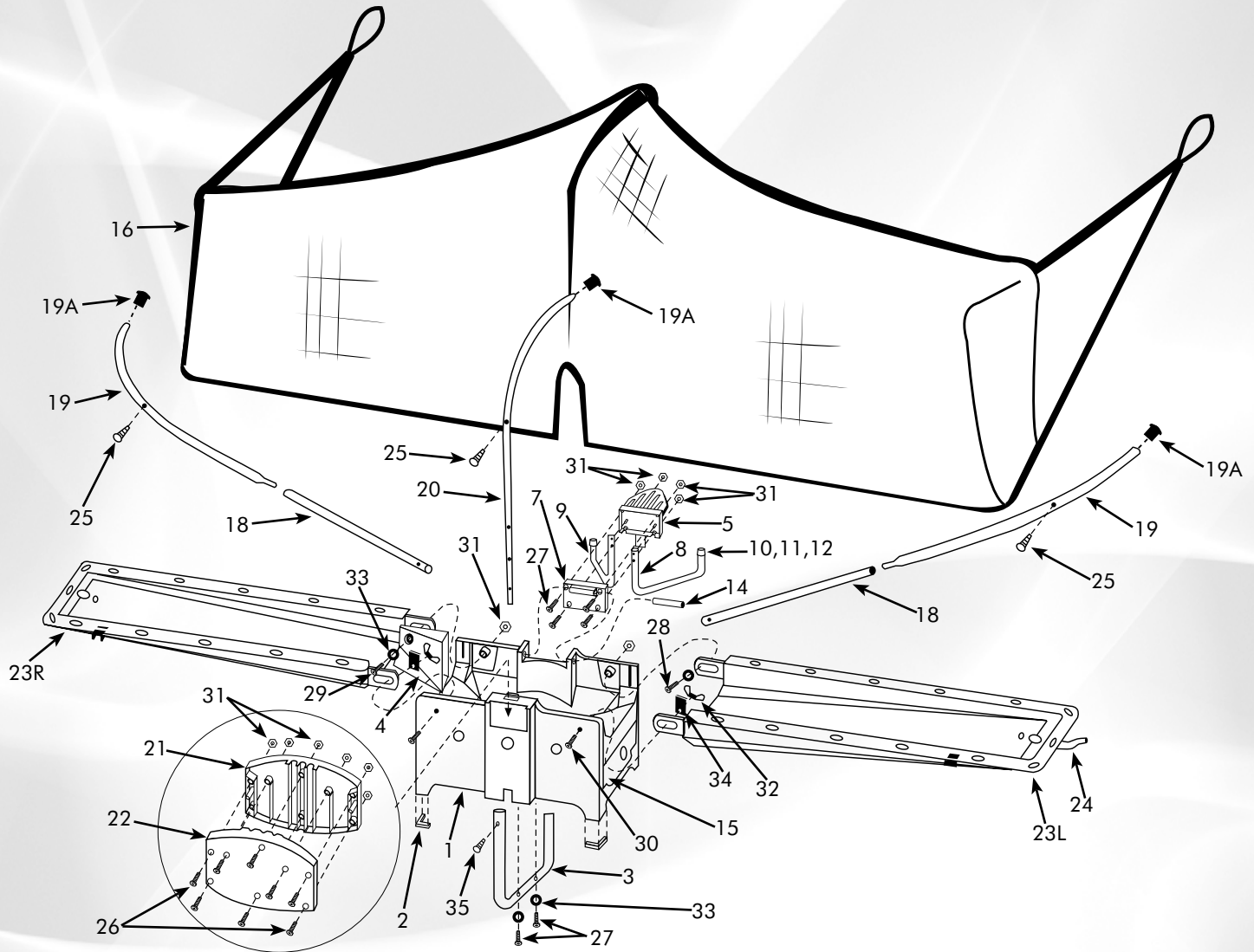

NOTE: The key numbers on this parts list correspond to the numbers used to identify parts in this manual.

Key#	Part #	Item	Qty.
1	2000-100	Center Trough	1
2	2000-101	CT Rubber Feet	4
3	2000-102	CT U-Shaped Support Tube	1
4	2040-103	CT Wedge Filler	1
5	2000-104A	CT Support Plate, Front	1
6	2000-106A	CT Front Support Plate Pad (not shown)	1
7	2000-108A	CT Support Plate, Back	1
8	2000-110	CT Support Leg, L	1
9	2000-112	CT Support Leg, R	1
10	2000-114	CT Support Leg Rubber Tip, 1/2"	2
11	2000-116	CT Support Leg Rubber Tip, 3/4" (std.)	2
12	2000-118	CT Support Leg Rubber Tip, 1"	2
13	2000-120	CT Rubber Spacer-Washer (not shown)	4
14	2000-122	CT Pivot Pin	1
15	2050-124A	CT Ball Dam, 40mm	2
16	2040-126B	Net, 40mm	1
17	18022-219	Plastic Clip (Fig. 18A, Pg. 20)	2
18	2000-128	Net Support Tube, Straight	2

Key#	Part #	Item	Qty.
19	2000-130	Net Support Tube, Curved, L & R	2
19A	2000-131	Net Support Tube Plug	3
20	2000-132	Net Support Tube, Curved, Center	1
21	2000-134A	Net Support Plate, Front	1
22	2000-136A	Net Support Plate, Back	1
23R	2000-138R	Ball Return Tray, Right	1
23L	2000-138L	Ball Return Tray, Left	1
24	2000-140A	Carrying Strap	1
25	2000-300	Net Retaining Screw	3
26	2000-302	#8 x 1" Machine Screw	8
27	2000-304	#8 x 3/4" Machine Screw	6
28	2000-306	#8 x 1/2" Machine Screw	1
29	2040-307	#8 x 5/8" Machine Screw	1
30	2000-308	#8 x 1" Hex Bolt	2
31	2000-310	#8 Hex Nut	16
32	2000-312	Wing Nut	2
33	2000-314	Large Washer	4
34	2000-315A	Clip Washer	2
35	2000-316	#8 x 3/8" Machine Screw	1

PARTS LIST FOR ROBOT BODY ASSEMBLY & BALL BUCKET

Key#	Part #	Item	Qty.	
36	1040-100A	Ball Bucket ¹	1	
37	1040-101	Ball Bucket Pad ¹	1	
38	1040-105	Bucket Extender ¹	1	
39	2050-142B	Ball Feed Back Panel, 40mm	1	
40	2050-143	BF Ball Sensor	1	
41	2000-144B	BF Collector Plate ²	1	
42	2050-145	BF Mounting Plate	1	
43	2040-147	BF Top Cap, 40mm	1	
44	2050-149	BF Main Gear	1	
45	2040-151B	BF Pickup Wheel, 40mm	1	
46	2040-153A	BF Pickup Finger, 40mm	3	
47	2050-155	BF Transfer Gear	2	
48	2050-157A	BF Spring, Long	1	
49	2050-158	BF Motor w/Gear	1	
50	2050-159A	BF Spring, Medium (L-Shaped)	1	
51	2000-160A	BF Power Wire (Figs. F & I, pg. 45)	1	
52	2040-161B	BF Spring, Short (Fig. I, pg. 45)	1	
53	2040-162A	BF Clear Front Cover, 40mm	1	
54	2050-164B	BF Upper Guide, 40mm	1	
55	2050-165	BF Upper Guide Cover	1	
56	2050-166	BF Discharge Tube, 40mm	1	
57	2000-168	BF Discharge Tube Brake	2	
57A	2050-169	BF Check Valve Spring	1	
58	2000-170A	BF Discharge Spring (Fig. D, pg. 44)	1	
59	2050-171	BF Ball Sensor Power Wire (Fig. F, p. 45)	1	
60	2050-313	BF Pickup Wheel Washer	1	
61	2050-317	BF Pickup Wheel Screw (LH Thread)	1	
62	2000-318	BF #4 x 5/16" Machine Screw	4	
63	2040-319	BF Spring Screw (Fig. I, Pg. 45)	4	
64	2050-327	BF Ball Sensor Screw (Fig. H, Pg. 45)	2	
65	2050-173	Robot Head Housing, L, 40mm	1	
66	2050-174	RH Housing, R, 40mm	1	
67	2050-177	RH Detent Pin	1	
68	<i>This part is no longer used</i>			
69	2050-180	RH Angle Adjustment Knob, 40mm	1	
70	2050-182	RH Angle Pointer	1	
71	2000-320	RH #8 x 1 3/16" Machine Screw	4	
72	2040-321	RH Pivot Screw	2	
73	2040-323	RH Pivot Screw Nut (Fig. E, Pg. 45)	3	
74	2050-329	RH Pivot Screw Washer	1	
75	2000-184	Ball Speed Motor w/Brass Shaft (Fig. C)	1	
76	2000-186B	BS Coiled Power Wire (Fig. F, Pg. 45)	1	
77	2000-188	BS Motor Cover	1	
78	2000-190	BS Discharge Wheel (Fig. C, Pg. 44)	1	
79	2040-192A	BS Friction Block, 40mm	1	
80	2050-193	BS Friction Block Bushing	1	
81	2000-324	BS Discharge Wheel Screw (LH Thread)	1	
82	2050-196A	Oscillator Pivot Guide, 40mm	1	
83	2050-201	Osc. Drive Pin	1	
84	2050-204	Osc. Servo Cover	1	
85	2050-211A	Osc. Servo, HT	1	
86	2050-210	Osc. Power Wire w/Connector (Fig. F)	1	
87	2050-325	Osc. Drive Pin Screw (Fig. B, Pg. 44)	1	
88	2050-218	5-Pin Connector	1	
89	2050-219A	5-Pin Connector PCB (Fig. F, Pg. 45)	1	
90	2000-328	#4 x 3/8" Self Tapping Screw	3	
90A	2000-328A	#4 x 3/8" Self Tapping Screw	16 ¹ /19 ²	
91	2000-330	#2 x 1/4" Machine Screw (Fig. C, Pg. 44)	4	

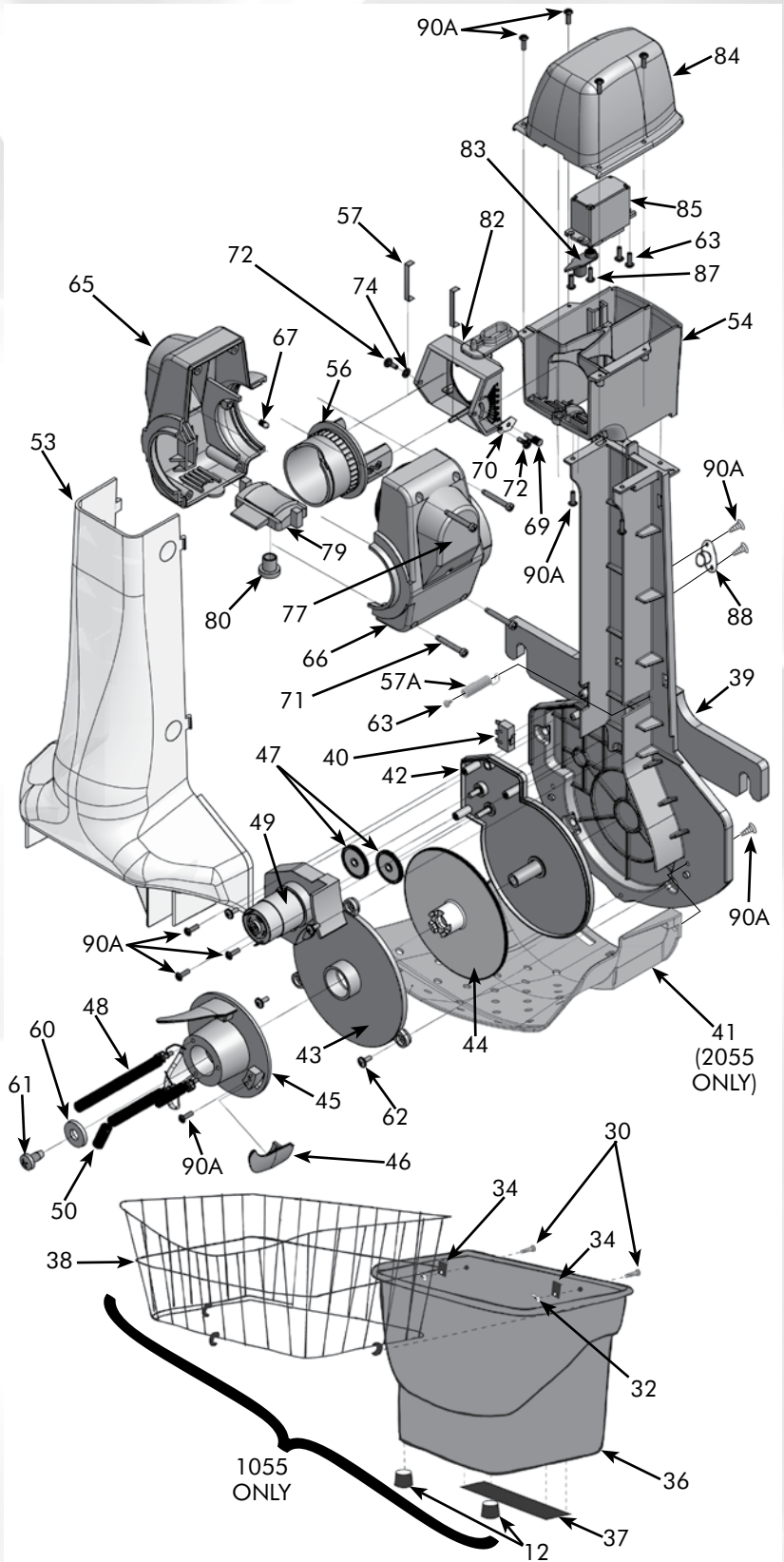

Key#	Part #	Item	Qty.
92	2050-220	Shielded Connector Cable (not shown)	1
93	2050-222B	Transformer Main Body (not shown)	1
94	2050-223B	Transformer Socket Adapter (see Pg. 37)	1
95	2050-224	Control Box (see Pg. 6)	1
96	2050-226	Control Box Bracket (see #8, Pg. 4)	1

¹Robo-Pong 1055 only; ²Robo-Pong 2055 only



Thank you for purchasing a Newgy Robo-Pong table tennis robot. We pride ourselves on extensive research and development, high quality manufacturing and thorough testing of our products. However, if an issue should arise or you need technical support, please contact our Technical Support Department at 1-800-556-3949. The warranty information below is applicable only to Newgy customers in North and South America. If you are in another part of the world, please contact the distributor for your area for service policies that apply to your country. A list of distributors can be found here.

Please call us for a return authorization number before you send in your robot for repair. Often, repairs can easily be handled over the phone. You can also visit <https://www.newgy.com/pages/suppor> to find answers to common questions. When you do call, please have your serial number (located on the back of your robot body and/or control box) and Owner's Manual handy. If, after talking with our Technical Support, you need to send in your robot, include a brief note describing the problem and list your daytime phone number and shipping address, as well as your return authorization number given by your Newgy representative.

If you know which part you need to order, you may order it by phone or request by email <https://www.newgy.com/pages/contact-newgy>. Parts are not available for purchase on Newgy.com.

LIMITED 1 YEAR WARRANTY*

Manufacturer warrants to the original retail purchaser of this product to be free from defects in material and workmanship for a period of 1 year from date of purchase.

Should this product become defective due to material or workmanship during the warranty period, contact our Technical Support Department describing the defect. Always provide your serial number. We will provide you with a return authorization number and shipping instructions. If you are asked to return the product, pack it securely and ship it PREPAID.

If defective as provided by the terms of this warranty, we will, at our discretion, repair or replace the product and return it prepaid to a continental U.S. address. Shipping charge may apply for other areas.

This warranty is not transferable and does not cover normal wear and tear, or damage caused by improper handling, installation, or use. This warranty is void if the product is in any way abused, damaged, or modified from its original state.

This warranty gives you specific legal rights, and you may have other rights that may vary from state to state.

SERVICE POLICY

When your 1 Year Limited Warranty expires, Newgy will repair any normal wear and tear to the robot for for a flat fee (depending on robot model), plus shipping and handling (for Contiguous U.S., other areas carry additional fees) for a period of 5 years from date of purchase. This policy does not cover damage due to abuse, misuse, or improper handling and applies only to the original retail purchaser of Newgy robots bought from an authorized Newgy USA dealer.

Please visit <https://www.newgy.com/pages/robo-pong-warranty-form> for current pricing.

OUT OF WARRANTY/SERVICE POLICY REPAIRS

When your 1 Year Limited Warranty and Service Policy expires, Newgy will repair any normal wear and tear to the robot for our current hourly service charge, plus the cost of parts and shipping and handling (for Contiguous U.S., other areas carry additional fees).

Your Warranty Card should be registered on line within 15 days of purchase. Go to <https://www.newgy.com/pages/robo-pong-warranty-form> to register. A place to copy the warranty information is given below. Be sure to keep your purchase receipt. We suggest you keep your receipt with this manual and record the following information:

Date Purchased _____ Serial # _____
 Store Name _____ City, State _____

*Warranty and service valid only in territory of original sale.



CONTACT US

Newgy Industries, Inc.
 Tennessee, USA
 800-556-3949
 615-452-6470
newgy@newgy.com
www.newgy.com

Manufactured under the following U.S. patents: 8758174, D663757, 5485995 & 4844458. Additional U.S. and foreign patents pending. Robo-Pong, Pong-Master, Robo-Balls, Pong-Pal, Newgy, and The Quicker Ball Picker Upper are trademarks owned or exclusively licensed to Newgy Industries, Inc., Tennessee, USA.

